



USER MANUAL

Model Number 650550

Rx ONLY

United States Federal Law restricts this device to sale by,
or on the order of, a licensed health care practitioner.

The Med4 Elite User Manual may be updated from time to time. The most current version of the User Manual can be found online in various languages at www.gameready.com.

If you require a paper copy of this manual, contact Game Ready Customer Service at 1.888.426.3732. International customers contact your local distributor.

دليل المستخدم هذا متوفر بلغات عدة على الموقع الإلكتروني
www.gameready.com

Dieses Betriebshandbuch ist in verschiedenen Sprachen online unter
www.gameready.com verfügbar

Este Manual del usuario está disponible en www.gameready.com en distintos idiomas

可前往在线获得本用户手册的多种语言版本
www.gameready.com

Denne brugervejledning kan findes online på forskellige sprog på www.gameready.com

Deze Gebruikershandleiding is online beschikbaar in verschillende talen op
www.gameready.com

Tämä käyttöopas löytyy netistä eri kielillä: www.gameready.com

On peut trouver ce manuel de l'utilisateur dans plusieurs langues en ligne à
www.gameready.com

Μπορείτε να βρείτε αυτό το Εγχειρίδιο Χρήσης σε ηλεκτρονική μορφή σε διάφορες γλώσσες
στη διεύθυνση: www.gameready.com

ניתן למצוא את המדריך הזה למשתמש בשפות שונות באתר www.gameready.com

Questo Manuale per l'utente è disponibile online in varie lingue su www.gameready.com

本ユーザー・マニュアルは、www.gameready.com
へ行けば様々な言語でオンライン閲覧できます。

www.gameready.com

에 가시면 이 사용자 설명서를 온라인에서 다양한 언어로 찾아보실 수 있습니다.

Niniejszą Instrukcję obsługi można znaleźć w internecie w różnych językach na stronie
www.gameready.com

Este Manual do Usuário pode ser encontrado online em vários idiomas em
www.gameready.com

Данную инструкцию по применению, а также ее переводы на различные языки,
можно найти на веб-сайте www.gameready.com

Denna användarhandbok finns tillgänglig på olika språk på nätet via
www.gameready.com

Bu Kullanıcı Kılavuzu, değişik dillerde çevrimiçi olarak www.gameready.com
adresinde bulunmaktadır

WELCOME TO MED4 ELITE



CONTENTS

Introduction to the Med4 Elite®

Indications for Use	2
Features	3
Compression Levels	3
Illustrations	4
Included Hardware and Documentation	5
Definitions.....	6

Safety

Med4 Elite Contraindications.....	7
General Warnings and Cautions	8
System Warnings and Cautions.....	9

Getting Started0

Setting Up.....	10
Filling the Reservoirs	10
Powering Up	10
Setting the Language	11
Changing Factory Settings.....	12
Personal Identification Number (PIN)	12

Med4 Elite At A Glance

User Interface Elements.....	13
Therapy Icons.....	14
System Settings Icons.....	15

Using the Med4 Elite

Setting the Temperature.....	16
Setting the Temperature Scale (°F / °C).....	16
Setting Up Therapy Sessions	16
Single Patient Therapy with One Wrap	17
Single Patient Therapy with Two Wraps	18
Two Patient Therapy	18
Heat Therapy	20
Cold Therapy.....	22
Rapid Contrast Therapy	24
Compression-Only Therapy.....	28

Pausing, Changing, and Stopping a Therapy	30
End of Therapy.....	31
Powering Down	31

Configuring Med4 Elite System Settings

Personal Identification Number (PIN)	32
Changing the PIN	32
Setting Defaults	33
Accessing System Settings.....	36
Heat Settings	37
Cold Settings.....	40
Snooze Function.....	43
Rapid Contrast Settings	44
Compression-Only Settings	50
Resetting the Med4 Elite to Factory Settings	52
Changing the Language.....	53
Working With Med4 Elite	
System Software and Information	54
Viewing System Information.....	54
Downloading Data.....	55
Updating the System Software	56

Storing, Cleaning and Maintaining the Med4 Elite

Storing.....	58
Cleaning and Maintaining.....	59
Control Unit and Connector Hoses	59
Control Unit Reservoirs	59
Control Unit Filter	60
Wraps	60
Adding Distilled Water	61
Water Reservoir Levels.....	61
Transporting the Med4 Elite	62
Moving Within the Facility	62
Transporting In A Vehicle.....	62
Disposing	62

Troubleshooting the Med4 Elite

Important Messages	63
Alarms	64
Error Codes	68

Repairing the Med4 Elite 68

Med4 Elite Product Specifications 69

Supplied Power Cord Specifications 70

UL Classification 72

Essential Performance 73

Electromagnetic Compatibility 73

Accessories and Replacement Parts

Accessories.....	76
Replacement Parts	76

Warranty

Manufacturer's Limited Warranty.....	76
How to Obtain Warranty Service	76
Warranty Registration.....	77
Warranty of Med4 Elite Accessories.....	77

Intellectual Property

Trademarks, Trade Names, Copyrights and Patents	77
Software License.....	77

Symbol Descriptions 78

Contact Game Ready..... 79

INTRODUCTION TO THE MED4 ELITE®

Based in Concord, California, and founded in 1997, Game Ready® (CoolSystems®, Inc.) is a best-in-class medical technology company that helps patients and athletes recover from injury or orthopedic surgery.

The first Game Ready System was launched in 2002 providing health-care practitioners with a state-of-the-art medical device that combines cold with active compression.

Building upon the breakthrough Game Ready technology, the Med4 Elite is a multi-modality recovery device for professional users. The system delivers iceless cold therapy, heat therapy, rapid contrast (alternating heat and cold) therapy, and intermittent pneumatic compression therapy providing healthcare practitioners with flexible treatment options for different patients, procedures, injuries and stages of rehabilitation.

Time-tested principles like RICE (Rest, Ice, Compression, Elevation) and heat therapy are taken to a new level with the use of the state-of-the-art Med4 Elite System. Cumbersome contrast therapy workflows are improved with the more compact and convenient footprint. Rapid contrast therapy techniques are improved with targeted, body-part specific, dual-action Game Ready Wraps. Heat therapy treatments can be set, monitored and controlled with better accuracy and consistency than traditional methods.

The advanced technology used in the Med4 Elite allows for treatment of two users simultaneously and utilizes the same anatomically designed Wraps as the Game Ready GRPro® 2.1 System. The device is controlled by an intuitive touch screen computer interface, allowing the user to manage the therapy modalities as well as easily adjust and monitor treatment times, temperature and compression settings.

A list of current patent(s) covering Game Ready technology can be found at: www.gameready.com/patents.

INDICATIONS FOR USE

The Med4 Elite® combines cold, heat, contrast, and compression therapies. It is intended to treat postsurgical and acute injuries to reduce edema, swelling and pain for which cold and compression are indicated. It is intended to treat post traumatic and post surgical medical and/or surgical conditions for which localized thermal therapy (hot or cold or contrast) are indicated. It is intended to be used by, or on the order of, licensed healthcare professionals in rehabilitation facilities, outpatient clinics, and athletic training settings.

FEATURES

The Med4 Elite offers four therapy options: Heat, Cold, Rapid Contrast and Compression-Only for one or two patients simultaneously. The features and available options that can be customized for each therapy session are shown in the table below.

Four Therapy Options (up to 2 Patients)	Temperature Levels	Treatment Time	Compression Level* (Intermittent Pneumatic)	Other Features
Heat	Set Minimum and Maximum, in °F or °C	Set total therapy time	Low & None	—
Cold	Set Minimum and Maximum, in °F or °C	Set total therapy time	Low, Medium-Low, Medium, High & None	Snooze function, up to 6 cycles
Rapid Contrast	Set Heat and Cold Minimum and Maximum, in °F or °C	Set Heat and Cold Cycle time and total therapy time	Heat: Low & None Cold: Low, Medium-Low, Medium, High & None	Start Rapid Contrast Therapy with either Heat or Cold Therapy
Compression-Only	—	Set total therapy time	Low, Medium-Low, Medium, High	—

COMPRESSION LEVELS

The Med4 Elite offers four compression levels for Compression-Only and Cold Therapy: **Low**, **Medium-Low**, **Medium**, and **High**, and one compression level for Heat Therapy: **Low**. Cold Therapy and Heat Therapy may also be administered with **No compression**.

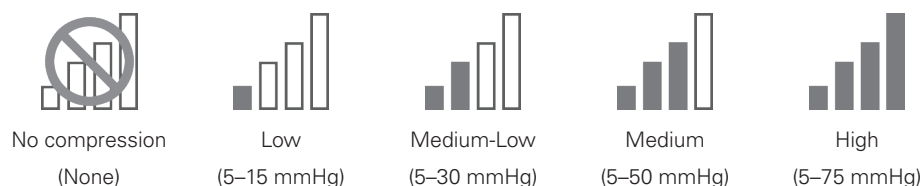

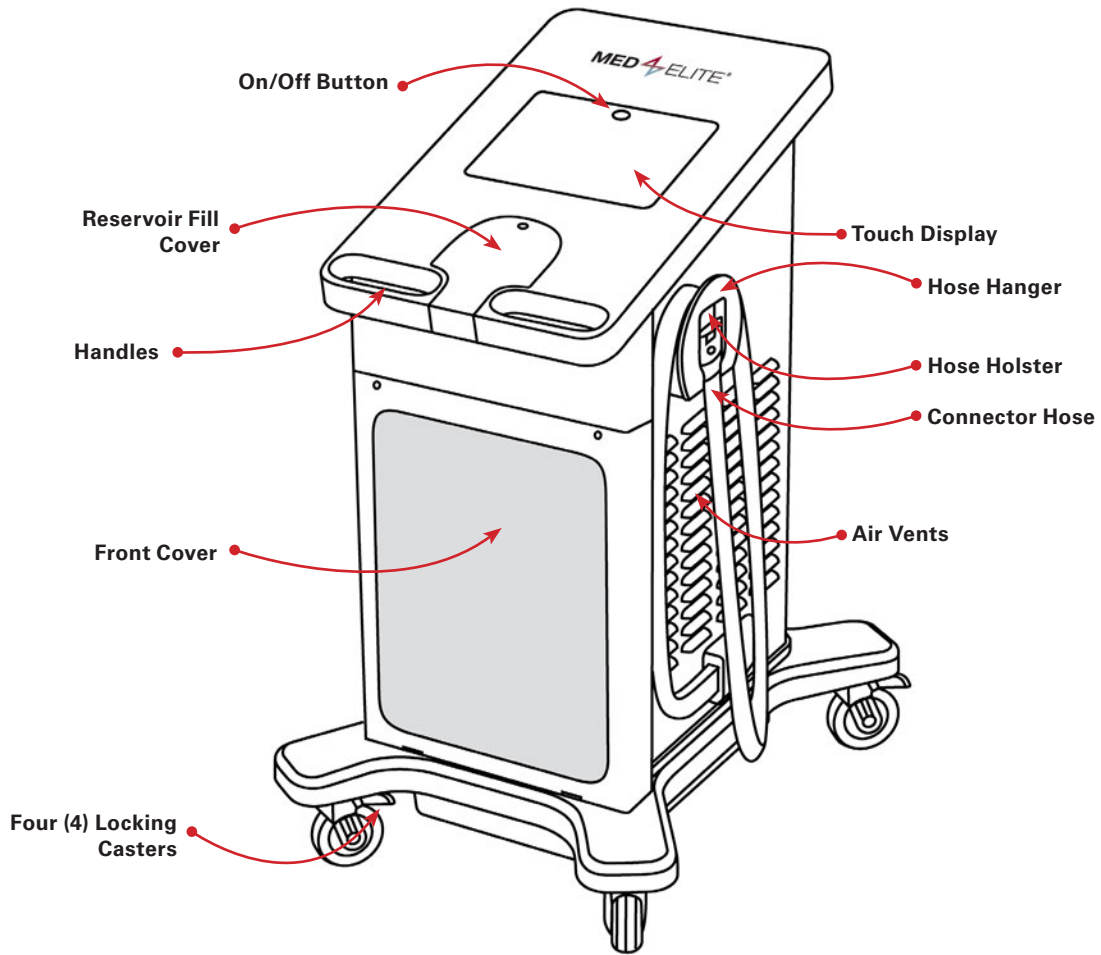

FRONT VIEW

WRAP

(Sold Separately)

A Wrap (comprised of an inner ATX® Series Heat Exchanger and an outer Sleeve) must be attached to the Med4 Elite to begin treatment. Each Wrap is sold separately and is not included with the Med4 Elite. Use only Game Ready Wraps with the Med4 Elite. Using products other than those manufactured or provided by Game Ready with the Med4 Elite may void the warranty.

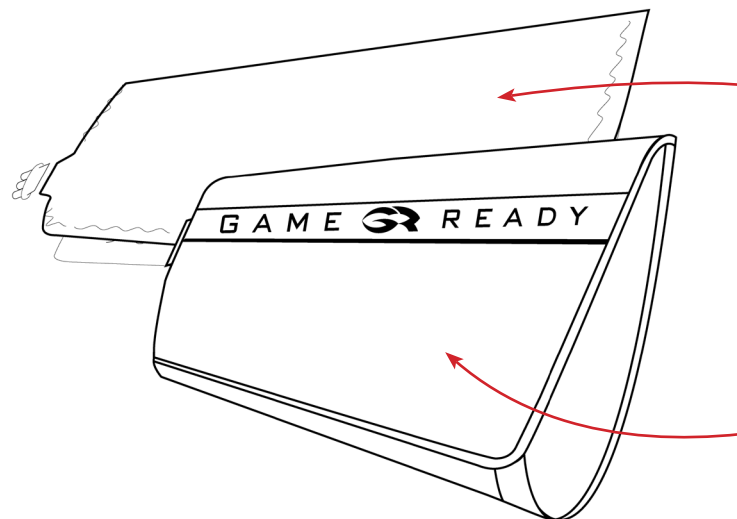

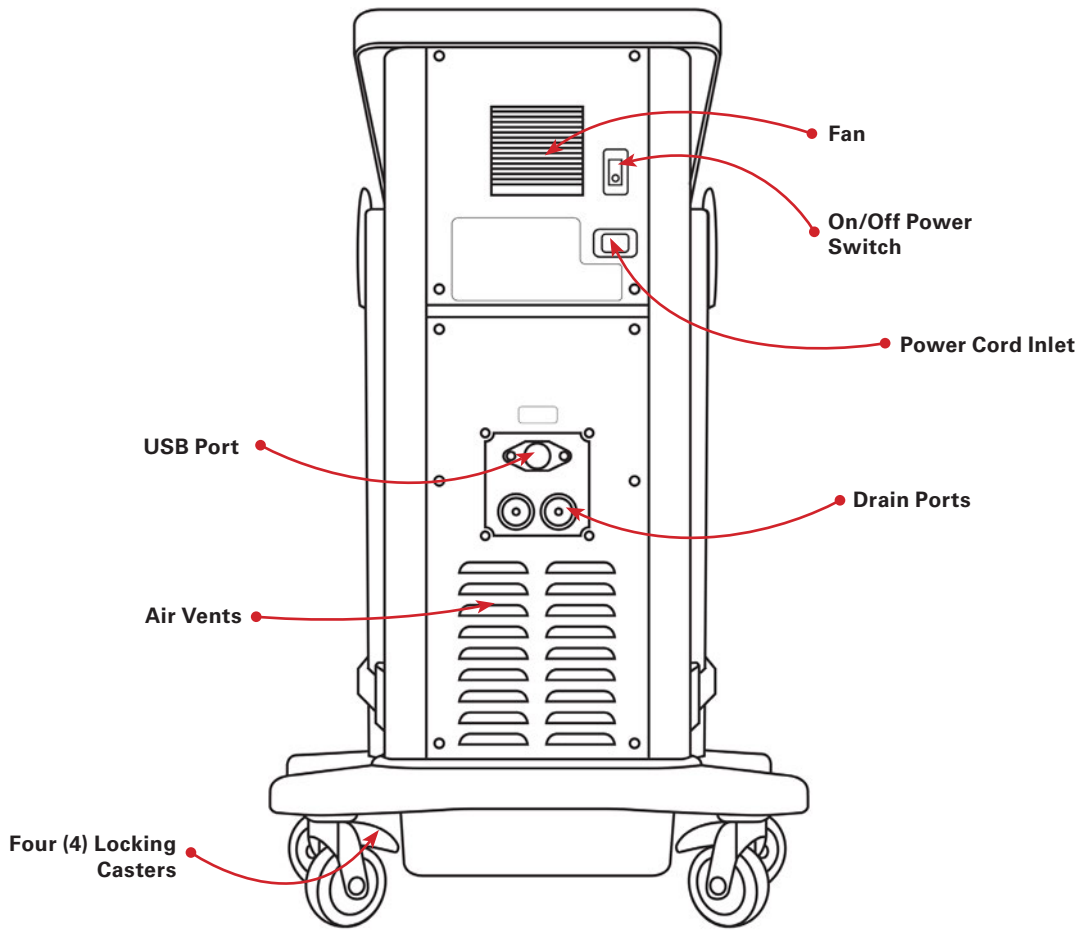

BACK VIEW

INCLUDED HARDWARE AND DOCUMENTATION

The following items are included with your system:

- 1 Med4 Elite Control Unit
- 1 Power Cord (~8 ft / 2.4 m)
- 2 Connector Hoses (attached to Control Unit)
- 2 Drain Hoses
- 1 User Manual
- 1 Quick Start
- 1 Quick Reference
- 1 Game Ready USB flash drive

ATX® Series Heat Exchanger

Sleeve

DEFINITIONS

Administrator	The person(s) having the authority to determine and set default System Settings for the facility.
Button	Those parts of the Graphical User Interface that users press to configure and control functions of the Med4 Elite operating system.
Active Button	A graphical button in the GUI that is currently selectable and will perform its intended function and/or purpose upon being pressed. Active buttons appear three dimensional and in full color.
Inactive Button	A graphical button in the GUI that is currently not selectable. Inactive buttons appear flat and grayed out.
Control Unit	The complete Med4 Elite device, including the operating system, internal hardware, cover, connector hoses, etc...
Graphical User Interface (GUI)	The means with which users interact with the Med4 Elite computer. The GUI is composed of icons, buttons, images, and other treatment information. Users press buttons to configure therapy sessions and System Settings and to control therapy sessions. Once started, the GUI displays the progress of active therapy sessions.
Icon	Med4 Elite GUI symbols that represent Med4 Elite patients, therapy modality levels, internal conditions and alarms.
On/Off Button	The button located at the top of the touch screen that powers the computer up and powers it down.
On/Off Switch	The toggle switch on the back of the Control Unit that supplies power to the system.
Patient	The person receiving therapy via the Med4 Elite.
Personal Identification Number (PIN)	The numeric password that allows the administrator to access Med4 Elite System Settings.
Reservoir	One of two receptacles inside the Control Unit that store, heat, and cool the water.
Reset	To return the Med4 Elite computer to factory settings.
Restart	The automated action that occurs after a user makes changes to System Settings: the Med4 Elite computer powers down and when turned on again, will operate with the new settings.
Screen	A Med4 Elite computer interface where users set Control Unit functions and monitor Control Unit activity. For example, the Select Patient screen.
Session	A single treatment.
Snooze	The amount of time in which no treatment is provided during Cold Therapy.
System	Refers to the entire Med4 Elite Control Unit.
System Shut Down	Powering down the Med4 Elite computer and turning the On/Off switch off.
Touch Screen	The glass panel that displays the Med4 Elite Graphical User Interface and with which Med4 Elite users physically interact with the Control Unit's computer by touching buttons that are displayed onscreen.
User	The person operating the Med4 Elite.

SAFETY

IMPORTANT: READ COMPLETE INDICATIONS, CONTRA-INDICATIONS, CAUTIONS AND WARNINGS BEFORE USING THIS PRODUCT

Caution: United States Federal Law restricts this device to sale by, or on the order of, a licensed health care practitioner.

Follow the treatment recommendations of your health care practitioner for duration and frequency of use for this device. A licensed health care professional should set up and supervise the use of this device for the patient.



WARNING: It is mandatory to fully read and understand the User Manual before using the device. Failure to follow operating instructions could result in serious injury.



ATTENTION: Consult User Manual.

MED4 ELITE CONTRAINDICATIONS

	THERAPY MODE			
	Thermotherapy	Cryotherapy	Compression	Rapid Contrast
<p>X = Absolute Contraindication – Therapy in these situations should not be used in patients who have:</p> <p>R = Relative Contraindication – Therapy for these conditions should be used only under the supervision of a licensed healthcare practitioner in patients who have:</p>				
Current clinical signs in the affected region of significant peripheral edema (e.g., deep vein thrombosis, chronic venous insufficiency, acute compartment syndrome, systemic venous hypertension, congestive heart failure, cirrhosis/liver failure, renal failure).	X	X	X	X
Significant vascular impairment in the affected region (e.g., from prior frostbite, arteriosclerosis, arterial insufficiency, diabetes, vascular dysregulation, or other vascular ischemic disease).	X	X	X	X
Known hematological dyscrasias that predispose to thrombosis (e.g., paroxysmal cold hemoglobinuria, cryoglobulinemia, sickle-cell disease, serum cold agglutinins).		X	R	X
Tissues inflamed as result of recent injury or exacerbation of chronic inflammatory condition.	X	R		X
Extremities with diffuse or focal impaired sensitivity to pain or temperature that prevent the patient from giving accurate and timely feedback.	X	R		X
Compromised local circulation or neurologic impairment (including paralysis or localized compromise due to multiple surgical procedures) in the affected region.	R	R	R	R
Cognition or communication impairments that prevent them from giving accurate and timely feedback.	X	R		X
An acute, unstable (untreated) fracture in the affected region.	X		R	X
Local malignancy.	X		R	X
Areas of skin breakdown or damage (damaged or at-risk skin) producing uneven heat conduction across the skin (e.g., open wound, scar tissue, burn or skin graft). Any open wound must be dressed prior to use of the Med4 Elite.	X	R	R	X
Actively bleeding tissue or hemorrhagic conditions.	X			X
Recently radiated tissues or areas affected by heat-sensitive skin diseases (e.g., eczema, psoriasis, vasculitis, dermatitis).	X			X
Localized unstable skin condition (e.g., dermatitis, vein ligation, gangrene, or recent skin graft) in the affected region.	R	R	R	R
Any active local or systemic infection.	X		X	X
Current clinical signs of inflammatory phlebitis, venous ulcers, or cellulitis.	R	X	X	X

	THERAPY MODE			
	Thermotherapy	Cryotherapy	Compression	Rapid Contrast
<p>X = Absolute Contraindication – Therapy in these situations should not be used in patients who have:</p> <p>R = Relative Contraindication – Therapy for these conditions should be used only under the supervision of a licensed healthcare practitioner in patients who have:</p>				
A pregnancy.	X			X
Any significant risk factors or current clinical signs of embolism (e.g. pulmonary embolus, pulmonary edema, cerebral infarction, atrial fibrillation, endocarditis, myocardial infarction, or arteromatous embolic plaque).		X	X	X
A condition in which increased venous or lymphatic return is not desired in the affected extremity (e.g., lymphedema after breast cancer or other local carcinoma and/or carcinoma metastasis in the affected extremity).		X	X	X
Raynaud’s disease or cold hypersensitivity (cold urticaria).		X		X
Hypertension, Cardiac failure, extreme low blood pressure, or decompensated cardiac insufficiency.	R	R	X	R
Children under 18 years old	R	R	R	R
Had recent toe surgery in the affected region.		R	R	R
Obtunded or with diabetes mellitus, multiple sclerosis, poor circulation, spinal cord injuries, and rheumatoid arthritis.	R	R	X	R
Decompensated hypertonia in the affected region.		X		X

IMPORTANT: Refer to the most up-to-date Wrap Use Guide for Wrap specific contraindications and warnings, which can be found at www.gameready.com

GENERAL WARNINGS AND CAUTIONS

- (General) Follow the treatment recommendations of your health care practitioner for duration and frequency of use for this device.
- (General) Improper placement or prolonged use of the Med4 Elite could result in tissue damage.
- (General) The Med4 Elite is not for use in a sterile environment.
- (General) Game Ready Wraps are not sterile; do not place directly against open wounds, sores, rashes, infections, or stitches. The Wrap may be applied over clothing or dressing.
- (General) A layer of clothing between Wrap and skin is recommended for all patients.
- (General) Game Ready Wraps are available in multiple configurations but are not intended for all possible physiologic uses. For example, the Ankle Wrap is not designed for use on the toes and the Back Wrap is not designed for use in the abdominal region.
- (General) Use extra caution during the immediate postoperative period, especially when sedated or on any medication that could alter normal pain sensation. Check the skin of the treated region

frequently and use mid-to-higher (warmer) temperature range settings or leave more time between treatments, if necessary.

- (General) During the course of therapy, patients should monitor the skin of the treated region, the surrounding area and the digits of the extremities of the treated limb (if applicable) for any excessive redness, blistering, signs of burning, light-headedness, generalized sweating (increased core temperature), itching, increased swelling, or pain. If any of these signs are present, or any changes in skin appearance occur (such as blisters, increased redness, discoloration, or other noticeable skin changes), patients are advised to discontinue use and consult a physician.
- Monitor the level of heat throughout treatment session. Caution should be used with the Med4 Elite System or any thermotherapy (Heat Therapy) device generating high intensity heat at 113°F or above. Check the skin of the treated region frequently and use mid-to-lower (cooler) temperature range settings or leave more time between treatments, if necessary.
- Device not intended for use with numbing agents.
- Heating of the gonads and developing fetus should be avoided.
- When using heat and rapid contrast therapy, skin should be protected in heat-sensitive or high-risk patients, especially over regions with sensory deficits.
- All Cryotherapy and Thermotherapy warnings and cautions also apply to Rapid Contrast Therapy.
- Compression Therapy in combination with Heat Therapy should only be used at a level that provides better (or firm) contact with the skin, but does not compress the tissues.

- **WARNING:** Use Carefully. May cause serious burns. Do not use over sensitive skin areas or in the presence of poor circulation. The unattended use of the Med4 Elite by children or incapacitated persons may be dangerous.
- Use extra caution if you are currently on any medication or have an underlying medical condition that predisposes to excessive bleeding or bruising.

Measured Skin Temperatures	
Maximum Temperature	Skin temperature measured as high as 111 °F (44 °C) when set to maximum Heat Reservoir set point
Minimum Temperature	Skin temperature measured as low as 44 °F (7 °C) when set to minimum Cold Reservoir set point

SYSTEM WARNINGS AND CAUTIONS

- To avoid the risk of electrical shock, do not remove any panels from the Control Unit. Opening the Control Unit will void the Med4 Elite warranty. For all servicing and repair, in the U.S. call Game Ready Technical Support at 1.888.426.3732 (+1.510.868.2100); from outside of the U.S. please contact your local distributor.
- To avoid electrical shock, product malfunction or damage, never operate the system with damaged power cords or Connector Hoses, or other mechanical damage, or if the unit is otherwise not fully operational.
- **WARNING:** To avoid the risk of electric shock, this equipment must only be connected to a supply mains with protective earth.
- **WARNING:** No modification of this equipment is allowed. Any modification, or attempt at modification, could be hazardous and will void the Med4 Elite warranty.
- Do not tip the Med4 Elite on its side.
- To avoid potential damage to the Med4 Elite, do not use other manufacturers' wraps with the Control Unit.
- To avoid injury, be careful not to trip over the Control Unit's power cords and Connector Hoses.
- Keep the Med4 Elite, including hoses and cords, away from children and pets.
- Use caution when handling small parts to reduce any possibility of swallowing or inhalation.
- The Med4 Elite Control Unit is a medical device. To avoid damage to your product, handle it with the same care as you would a laptop computer. Do not drop it, kick it or otherwise abuse it. Such abuse will void the Med4 Elite warranty.
- Use only distilled water to fill device.
- Perform routine cleaning and water disinfection per instructions.

- Fill reservoirs with distilled water per instructions before supplying power to the device.
- Device contains R-134a refrigerant, to be serviced by qualified technicians only.
- The cooling system in your Med4 Elite contains R-134a, a refrigerant covered by the United States Environmental Protection Agency's (EPA) disposal regulations and potentially other international environmental agencies. To avoid confusion and potential environmental damage, contact your local waste facility and inquire about disposal procedures for the Med4 Elite.
- **WARNING:** To safely interact with the Med4 Elite touch screen, you must be standing within 1 foot (30 cm) directly in front of the device.
- Use only Game Ready supplied Power Cord. See *Supplied Power Cord Specifications* for details.

- Use of this equipment adjacent to or stacked with other equipment should be avoided because it could result in improper operation. If such use is necessary, this equipment and the other equipment should be observed to verify that they are operating normally.

-  This symbol on the Control Unit or its packaging means that this product must not be disposed of with household/consumer waste. To learn where to drop off your electrical and electronic waste, please contact your local city/municipal waste disposal service office or contact Game Ready for assistance.

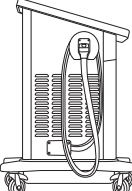
-  In order to prevent trip hazards, the connector hose(s) must be properly placed in the holster(s) when not in use. Wrap the Hose once around the Hose hanger and place the end into the holster as shown. Ensure the numbered Hose Connector corresponds with the number on the Hose hanger.

 **WARNING:** To comply with California Proposition 65, the following warning has been included. This product can expose you to chemicals including cadmium, chromium, lead, polybrominated biphenyls, or mercury, which are known to the State of California to cause cancer or reproductive toxicity. For more information go to www.prop65warnings.ca.gov.

GETTING STARTED

SETTING UP

The Med4 Elite arrives with a Quick Start located in the Accessory Kit box. Please read the instructions carefully before powering up and operating the device.

Use the handles to move the Control Unit into place. The Control Unit should be set up:

- within six feet of a power outlet with a dedicated electrical circuit or enough power to supply 1200 watts
- with adequate access to the On/Off Switch on the back of the unit and with the power cord unobstructed
- on level ground within the facility
- indoors only
- in a dry location
- so that vents on all sides are unobstructed
- free of trip hazards

IMPORTANT: The Med4 Elite should never be tipped on its side. Tipping of the control unit may cause damage to the compressor and may void the warranty.



Once the device is located in a suitable location, lock the casters in place by pressing down on all four caster locks until they click into the down and locked position.

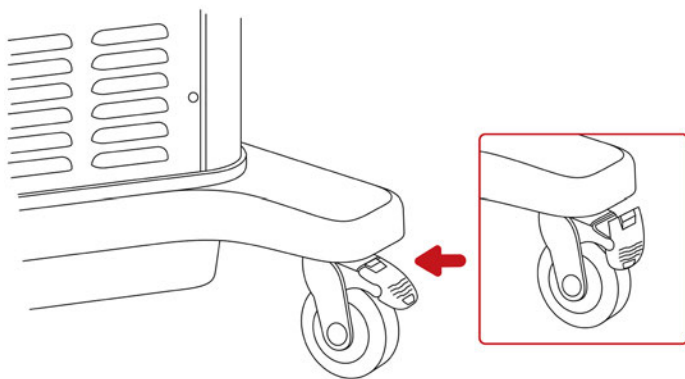

FILLING THE RESERVOIRS

The Med4 Elite ships with the reservoirs empty. You will need to fill the reservoirs prior to use. Two gallons (eight liters) of distilled water are needed to completely fill the reservoirs.

IMPORTANT: Use distilled water only. DO NOT use deionized water or tap water. Failure to use distilled water may void the warranty of the device.

1. The reservoir opening is located below the touchscreen on the Control Unit. Open by pressing on the cover to release the latch and lift.
2. Carefully pour distilled water into the reservoir opening.
3. When finished filling the reservoirs, close the cover. Press firmly to engage the latch.

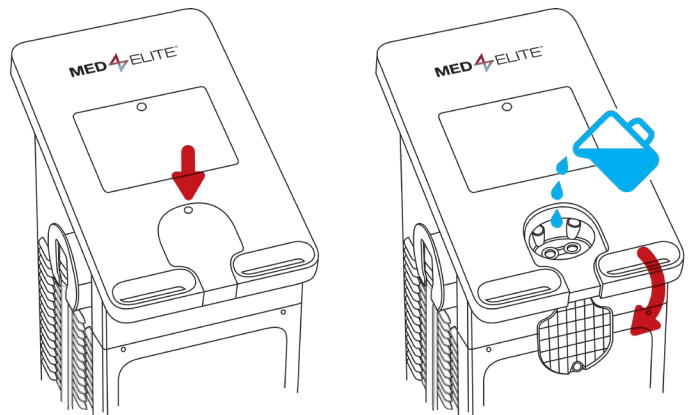

POWERING UP

Connections and Powering Up

1. Attach the supplied power cord to the back of the Control Unit.
2. Plug the power cord into the appropriate power outlet.

IMPORTANT: Place the power cord in a safe location to prevent tripping hazards or inadvertent disconnection.

3. Turn on the power switch located on the back of the Control Unit. A tone will play indicating the Med4 Elite is powering up.

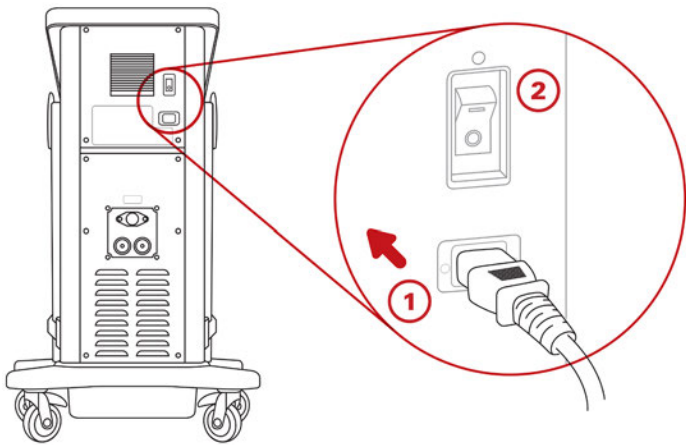

After you switch the power on, the On/Off button at the top of the touch screen illuminates in amber.

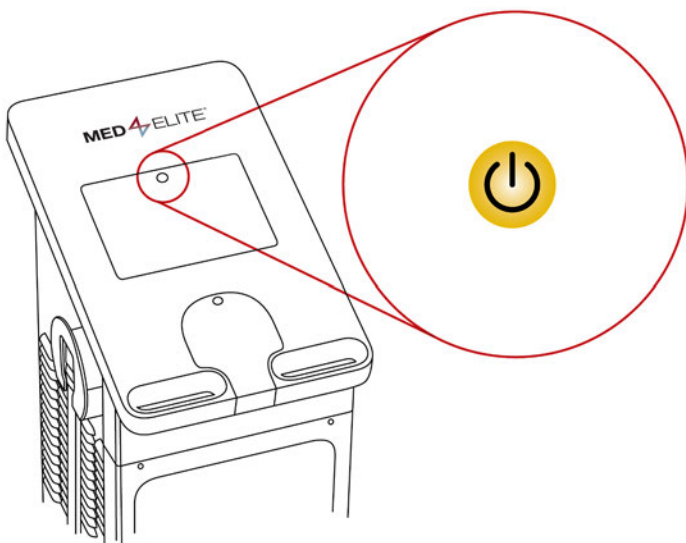

4. Press the On/Off button to turn on the Med4 Elite. The On/Off button at the top of the touch screen will turn green.

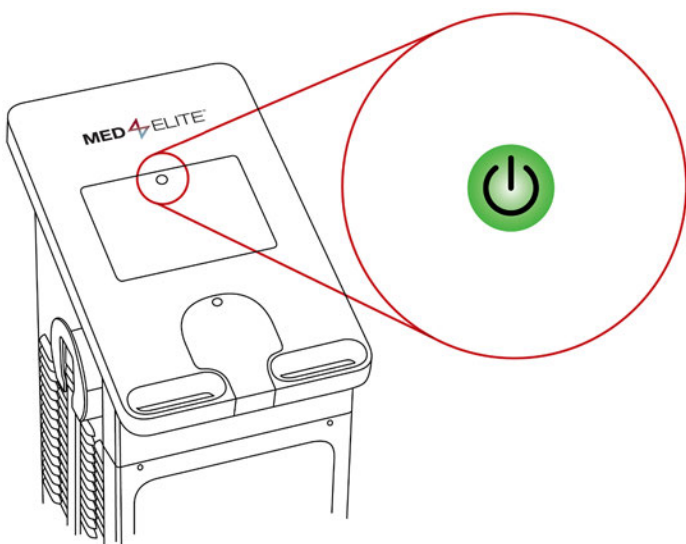



The Med4 Elite operating system takes up to 60 seconds to load.

SETTING THE LANGUAGE

The first task you will be asked to complete with your Med4 Elite is to select and confirm a Language for the user interface.

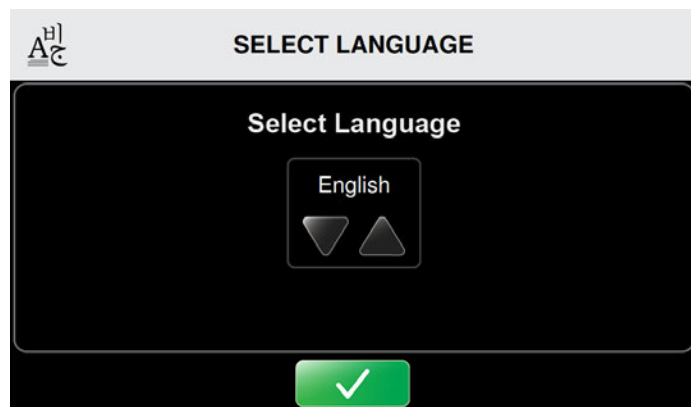

On the initial boot, the Select Language screen appears.

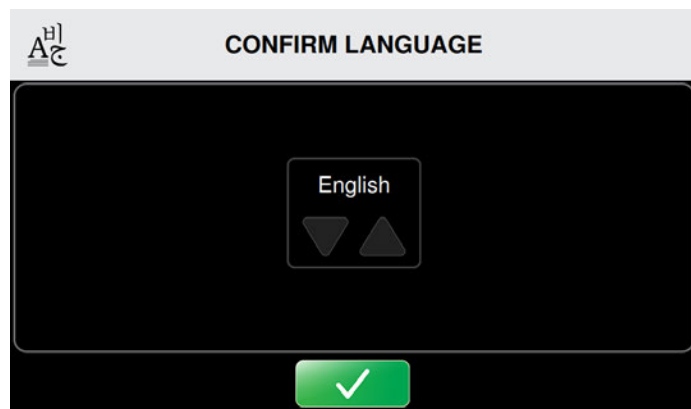

1. Press the up or down arrows to scroll through the available languages.
2. To select the default language setting, press the  Confirm button.

The Confirm Language screen appears.



3. To confirm the default language setting, press the  Confirm button.
4. Restart to Apply Settings by pressing the  Confirm button a second time.

The Control Unit's computer powers down.

5. Press the On/Off button located at the top of the touch screen to restart the computer.

Upon powering the Control Unit back on, the Select Patient screen will appear. The Med4 Elite is now ready for use. Select a patient to begin setting up a therapy. See *Using the Med4 Elite* for further instruction.

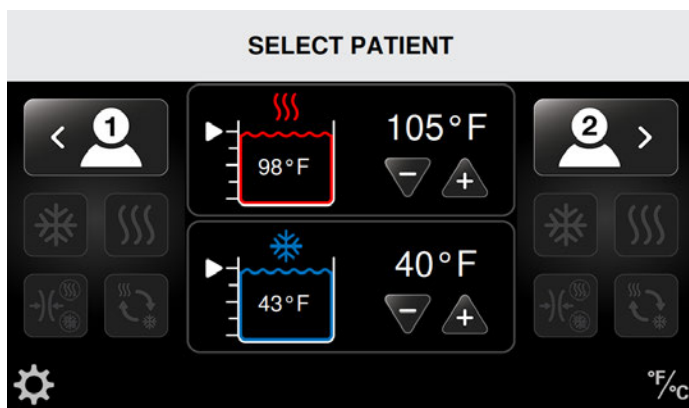

IMPORTANT: If the Control Unit detects an insufficient amount of water in the reservoirs, you will not be allowed to continue until adding an adequate amount of water.

FILL RESERVOIRS TO CONTINUE...

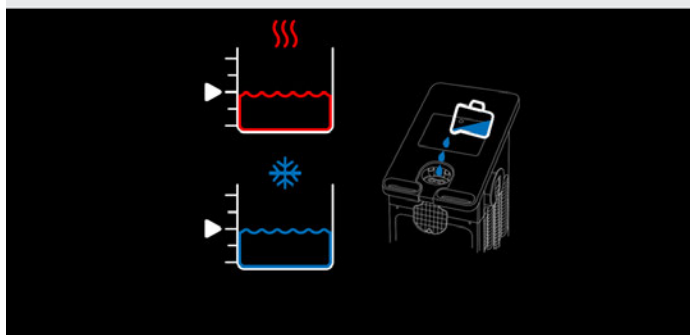

It is important that you fill the reservoirs prior to turning on the Med4 Elite. If it is turned on without water, or with an insufficient amount of water, you will be prompted to add water before continuing. See *Filling the Reservoirs* for instruction. Once both reservoir levels reach at least 75%, the Select Patient screen will automatically appear, and the Med4 Elite is now ready for use.

CHANGING FACTORY SETTINGS

The Med4 Elite ships with factory settings that define the default settings for therapy sessions. Settings include minimum, maximum and default heat and cold temperatures; minimum, maximum and default compression, minimum, maximum and default therapy session times, reservoir temperatures, interface language, and temperature scale.

These settings determine the allowable temperature and compression ranges for therapy sessions, as well as the default settings you see when you start up the Control Unit.

You can use the Med4 Elite with factory settings, or you can change these settings to meet the requirements of your facility at any time.

To view the factory settings and the procedures to change the settings, refer to *Configuring Med4 Elite System Settings*.

PERSONAL IDENTIFICATION NUMBER (PIN)

The Med4 Elite is delivered with a factory default PIN. **The factory default PIN is 1111.** The PIN is necessary to access System Settings and to change default settings. You may change the PIN number in System Settings, refer to *Configuring Med4 Elite System Settings*. Please remember to keep your PIN secure and accessible.

IMPORTANT: If you lose or forget your PIN, call Game Ready Technical Support and request a Master PIN. This will allow you to access the System Settings to configure a new PIN. You can contact Game Ready Technical Support at 1.888.426.3732 (1.888.GameReady) and +1.510.868.2100. From outside the U.S., contact your local distributor.

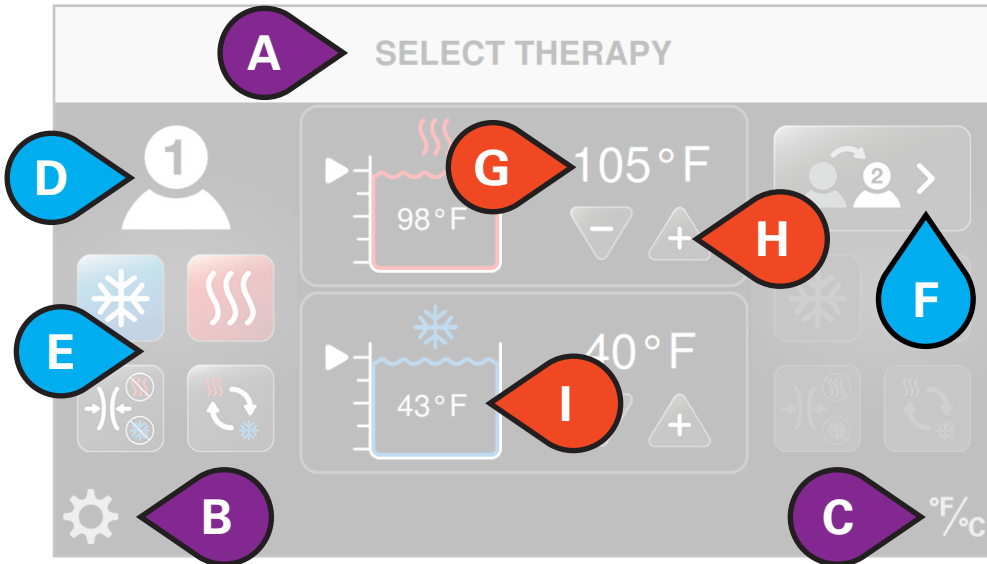

USER INTERFACE ELEMENTS

- A. Screen Title
- B. Access System Settings
- C. Toggle Temperature Scale between °F and °C
- D. Selected Patient
- E. Available Therapies
- F. Switch Patient
- G. Target Reservoir Temperature
- H. Decrease or Increase Target Temperature
- I. Actual Reservoir Temperature

- J. Type of Therapy in Progress
- K. Total Time Remaining
- L. Stop Therapy
- M. Pause Therapy
- N. Compression Level
- O. Add Patient
- P. Actual Heat Reservoir Temperature
- Q. Actual Cold Reservoir Temperature

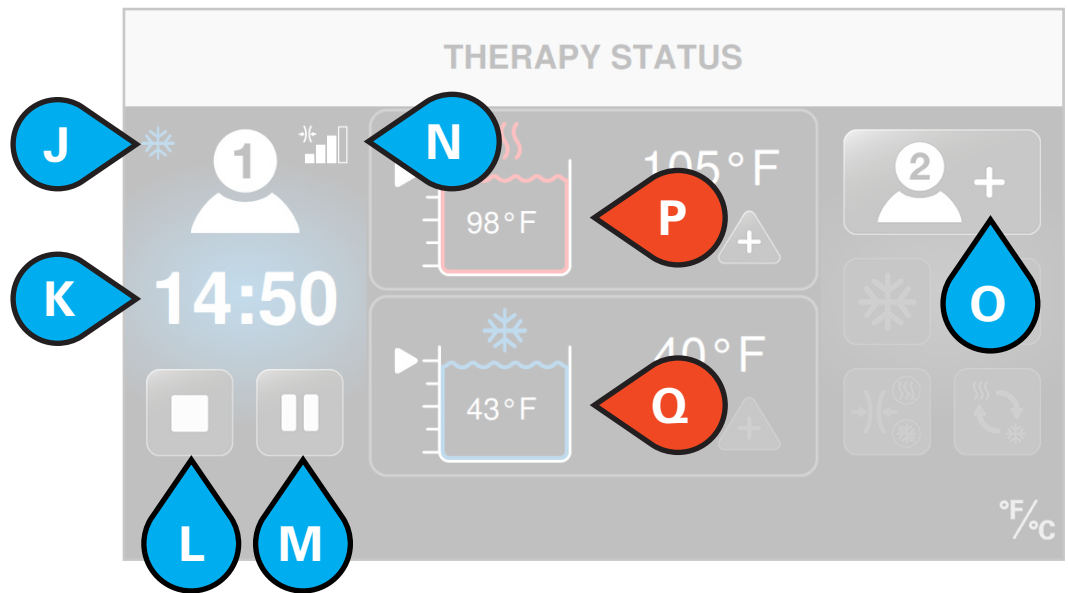





















 PATIENT OPTIONS



















 TITLES / SETTINGS

 RESERVOIR OPTIONS

THERAPY ICONS





















The User Interface uses icons to control the Med4 Elite.













Icon	Name
	Access System Settings
	Toggle between Fahrenheit (°F) and Celsius (°C)
	Heat Reservoir Level and Current Reservoir Temperature
	Cold Reservoir Level and Current Reservoir Temperature
	Increase setting
	Decrease setting
	Start Therapy
	Cancel
	Pause Therapy
	Stop Therapy
	Patient 1 Add
	Patient 1 Select
	Patient 1 Switch
	Patient 2 Add
	Patient 2 Select
	Patient 2 Switch
	Cold Therapy
	Adjust Cold Therapy Settings
	Toggle Snooze On
	Toggle Snooze Off

Icon	Name
	Snooze Total Number of Cycles
	Snooze Cycle Status
	Heat Therapy
	Adjust Heat Therapy Settings
	Rapid Contrast Therapy
	Adjust Rapid Contrast Therapy Settings
	Set Beginning Therapy
	Rapid Contrast Therapy Heat Time
	Rapid Contrast Therapy Cold Time
	Rapid Contrast Therapy Total Time
	Compression-Only Therapy
	Adjust Compression-Only Therapy Settings
	No compression (None)
	Low compression (5–15 mmHg)
	Medium-Low compression (5–30 mmHg)
	Medium compression (5–50 mmHg)
	High compression (5–75 mmHg)
	General Alarm
	Attention: Consult User Manual

SYSTEM SETTINGS ICONS

The System Settings User Interface uses icons to control the default settings of the Med4 Elite.

Icon	Name
	Access System Settings
	Change Personal Identification Number (PIN)
	Factory Reset
	Language Settings
	System Information
	Data Download
	Software Update
	Cold Therapy Settings
	Cold Therapy Time Settings
	Cold Therapy Compression Settings
	Cold Reservoir Temperature Settings
	Snooze Settings
	Enable Snooze
	Disable Snooze
	Heat Therapy Settings
	Heat Therapy Time Settings
	Heat Therapy Compression Settings
	Heat Reservoir Temperature Settings
	Rapid Contrast Therapy Settings
	Rapid Contrast Time Settings

Icon	Name
	Compression-Only Therapy Settings
	Compression-Only Therapy Time Settings
	Cancel
	Confirm
	Return
	Start
	Exit to Save Settings (Restart Required)
	No compression (None)
	Low compression (5–15 mmHg)
	Medium-Low compression (5–30 mmHg)
	Medium compression (5–50 mmHg)
	High compression (5–75 mmHg)

USING THE MED4 ELITE

SELECT PATIENT

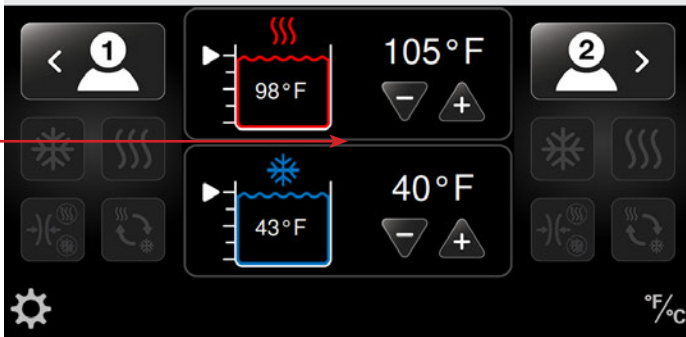

SETTING THE TEMPERATURE

The Med4 Elite has two water reservoirs that are used to achieve the desired therapy temperature. One is used for Heat Therapy and one is used for Cold Therapy. Reservoir temperatures can be set from the *Select Patient* screen shown above.

- It is recommended that reservoir temperatures are set for the most common therapy temperatures at the start of the work day.
- Or the reservoir temperatures can be set in the Administrative Settings to default temperatures when the Med4 Elite is turned on.
- If a therapy requires a change from the set reservoir temperature, the new reservoir temperature can be selected from the *Select Patient* screen prior to setting up the patient therapy. This allows the reservoirs time to reach desired temperatures prior to treatment.

NOTE: See *Safety > General Warnings and Cautions* for expected maximum and minimum skin temperatures.

ADJUSTING RESERVOIR TEMPERATURE WHEN SHARED BETWEEN TWO PATIENTS

The Med4 Elite reservoirs are shared between patients. When two patients are being treated with therapies that use the same reservoir, the therapy temperature will be the same for both patients.

When setting up a therapy for the second patient that uses the same reservoir as the first patient, the therapy temperature selection (+ or -) buttons will be inactive. The reservoir temperature will remain at the temperature set for the first patient. If a different temperature is desired, all therapies must first be paused in order to adjust the reservoir temperature. Attempting to change the temperature while a therapy is in progress will display the *Heat/Cold Reservoir in Use* message.

To change the reservoir temperature:

1. Pause treatment on the first patient, and adjust the temperature.
2. This adjusted temperature will be the same for both patients.

3. Resume therapy for the first patient by pressing the Start button.
4. Set up the second patient and press the Start button.

SETTING THE TEMPERATURE SCALE (°F / °C)

The Med4 Elite enables you to view temperatures in either Fahrenheit (°F) or Celsius (°C). From any screen you can quickly switch between the two.

For example, to set the temperature scale from the *Select Patient* screen:

SELECT PATIENT

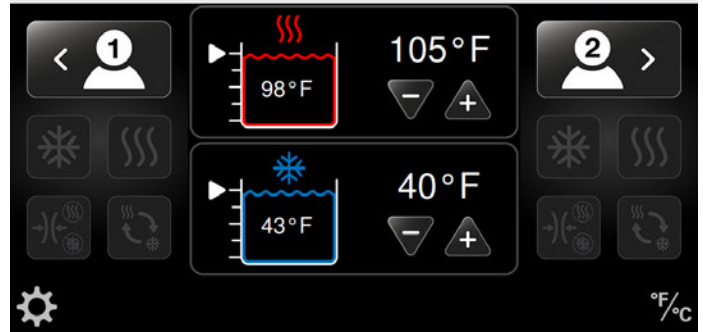

1. Press the temperature scale icon in the lower right corner of the screen.

The temperature scale switches. In this example, the scale switches from Fahrenheit to Celsius.

SELECT PATIENT

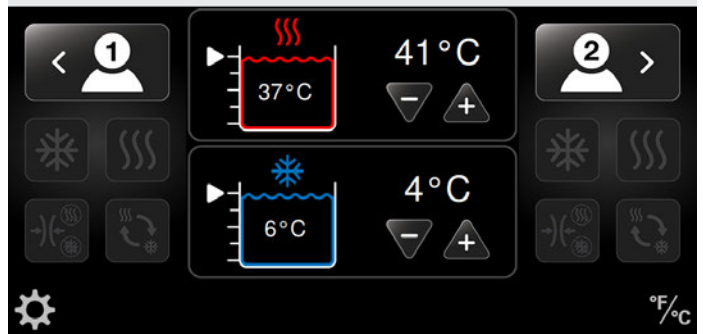

SETTING UP THERAPY SESSIONS

The Med4 Elite allows you to set up individual therapy sessions for up to two patients at a time. Therapy modalities include:

- Heat Therapy (Thermotherapy) with or without compression
- Cold Therapy (Cryotherapy) with or without compression
- Rapid Contrast Therapy (rapidly alternates between Heat and Cold therapies) with or without compression
- Compression-Only Therapy (no water flow)

You can pause, stop or change therapies at any time during treatment.

IMPORTANT: The default settings determine the minimum, maximum and default temperatures, compression levels and therapy times for individual treatment sessions.

These settings are set at the factory or by your facility administrator. Refer to *Configuring Med4 Elite's System Settings* in this manual for more information.

The Med4 Elite allows for a single patient therapy or up to two patients to receive therapy simultaneously. When two patients receive treatment, you can individualize the treatment sessions for each patient.

SINGLE PATIENT THERAPY WITH ONE WRAP

To set up a therapy session for a single patient:

1. Apply the desired Wrap to the patient and attach the Wrap to the Hose. When you hear a click, you have connected the Wrap correctly.

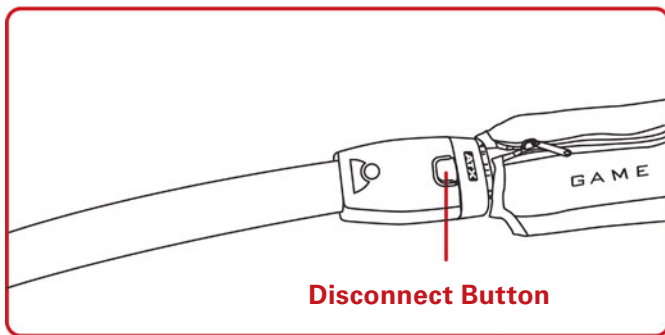
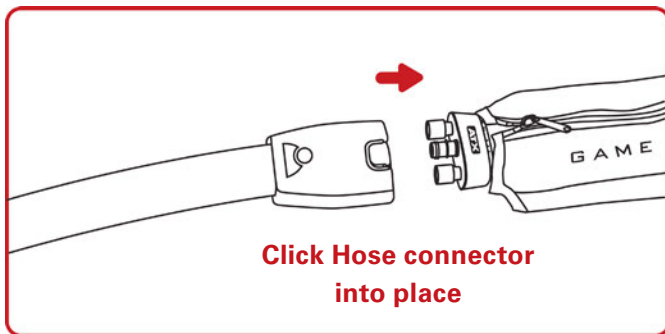

2. Select the desired patient by pressing the Patient Icon: Patient 1 is on the left side of the screen or Patient 2 is on the right side of the screen. This selection allows you to adjust settings for the desired patient.

NOTE: You can set up the patient as either Patient 1 or Patient 2. If you set up a patient on the Hose marked with the number 1, configure that patient as Patient 1 in the user interface. If you set up a patient on the Hose marked with the number 2, configure that patient as Patient 2 in the user interface.

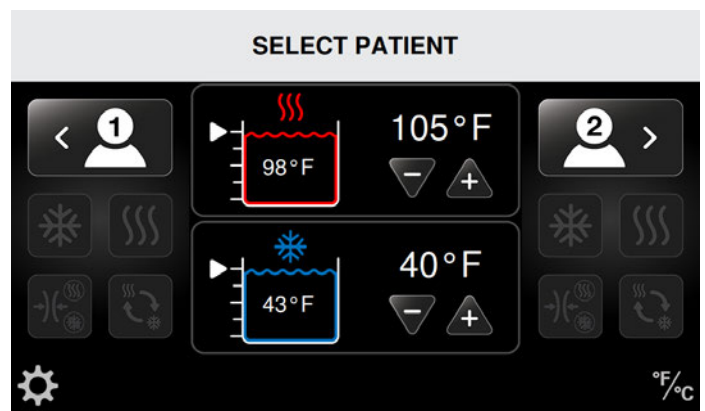
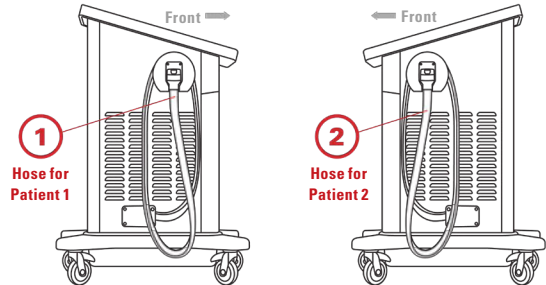

The Select Therapy screen appears with four active therapy icons. (In the following example, Patient 1 is selected. However, if you need to switch to Patient 2 instead, press the Patient 2 Switch button.)

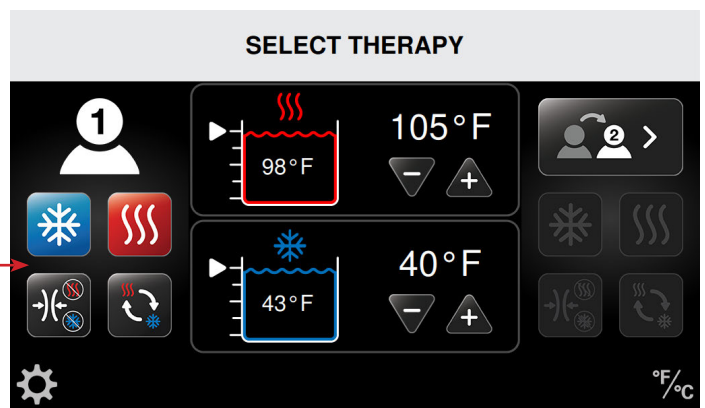

3. Select the desired therapy.

For setting up these therapies, refer to the procedures in the appropriate section in *Using the Med4 Elite*:

- Heat Therapy
- Cold Therapy
- Rapid Contrast Therapy
- Compression-Only Therapy

In the following example, Cold Therapy is selected.

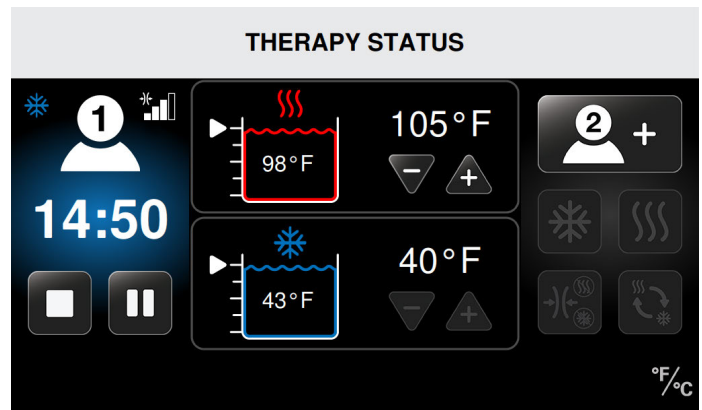
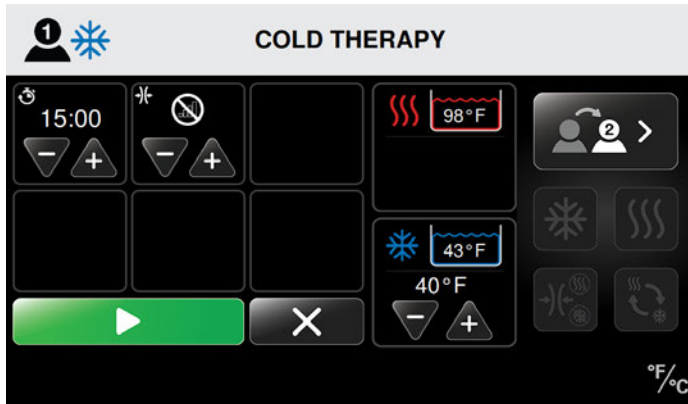

In this example, Patient 1's session is in progress with:

- Cold Therapy
- Medium compression
- 14:50 minutes of Cold Therapy remaining
- Cold Therapy temperature set to 40 °F (4 °C)
- Actual reservoir temperature is 43 °F (6 °C)

- Once you have selected the patient's therapy settings and the treatment temperature reaches the set point, press the Start button to begin the therapy session.
- Press the Cancel button to go back to the main screen without starting the session. By returning to the main screen, settings will not be saved.

When the session starts, the Therapy Status screen displays the session time as a countdown for the total treatment time. The screen also shows the type of therapy, treatment temperatures, the compression levels, and the reservoir temperatures and water levels. From this screen, you can stop or pause treatment.

SINGLE PATIENT THERAPY WITH TWO WRAPS

OR

TWO PATIENT THERAPY

IMPORTANT: For Two Patient Therapy sessions, the heat and cold reservoirs are shared between patients. Therefore, the temperatures will be the same for both patients. **When setting up a therapy for the second patient that uses the same reservoir as the first patient, the therapy temperature selection (+ or -) will be inactive.** The reservoir temperature will remain at the temperature set for the first patient. If a different temperature is desired, all therapies must first be paused in order to adjust the reservoir temperature. Attempting to change the temperature while a therapy is in progress will display the *Heat/Cold Reservoir in Use* message.

If you want to change the reservoir temperature before adding a second patient, you will first need to pause treatment on the first patient and adjust the temperature. This new temperature will affect both patient therapies. See *Pausing, Stopping and Changing Therapy Sessions*.



To add a second patient after first setting up a single patient (see previous section *Single Patient Therapy*):

- Select the appropriate Wrap and attach it to the Hose. When you hear it click, you have connected the Wrap correctly.

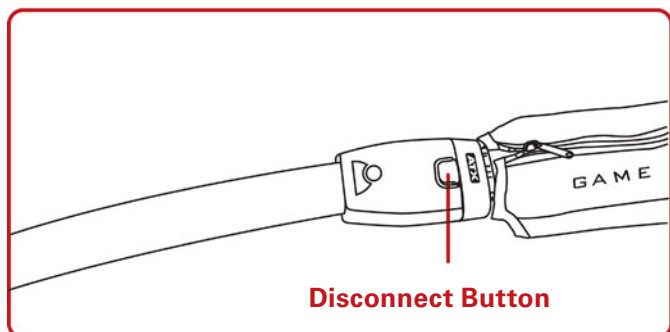
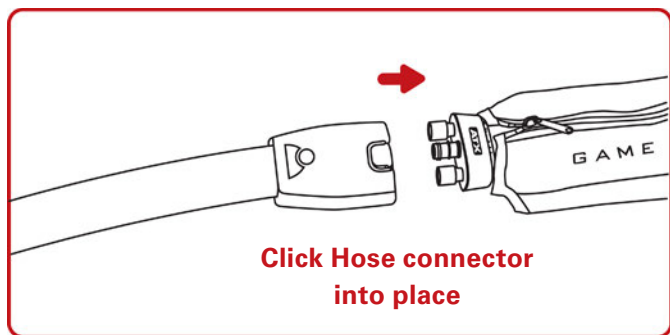

NOTE: If the unused Hose is marked with the number 1, configure the second patient as Patient 1 in the user interface. If the unused Hose is marked with the number 2, configure the second patient as Patient 2 in the user interface.

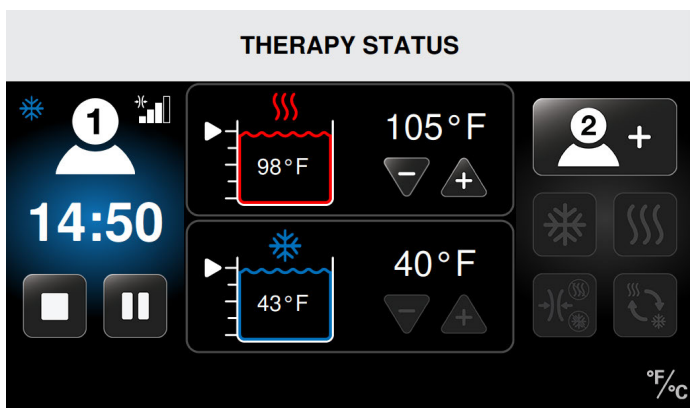
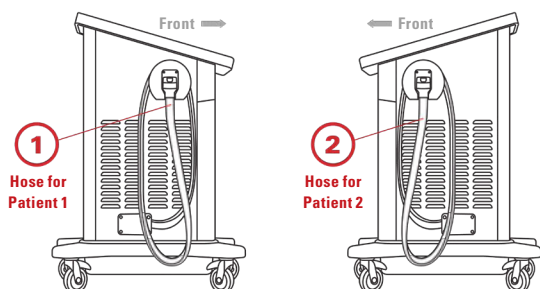

2. Select either Patient 1 Add or Patient 2 Add (based on whichever Hose is available) by pressing the Patient Add icon on the Therapy Status screen. This allows you to adjust settings for the second patient or a second wrap for a single patient.

Once you select the Patient, the four therapy icons become active. (In this example, Patient 2 is selected for a new therapy to be set up, and Patient 1 is receiving Cold Therapy.)

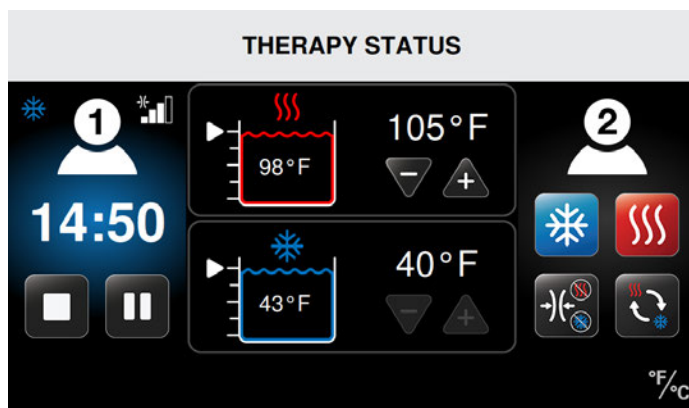

3. Select the desired therapy.

For setting up these therapies, refer to the procedures in the appropriate section in *Using the Med4 Elite*:

- Heat Therapy
- Cold Therapy
- Rapid Contrast Therapy
- Compression-Only Therapy

In the following example, Heat Therapy is selected for Patient 2 while Cold Therapy continues for Patient 1.

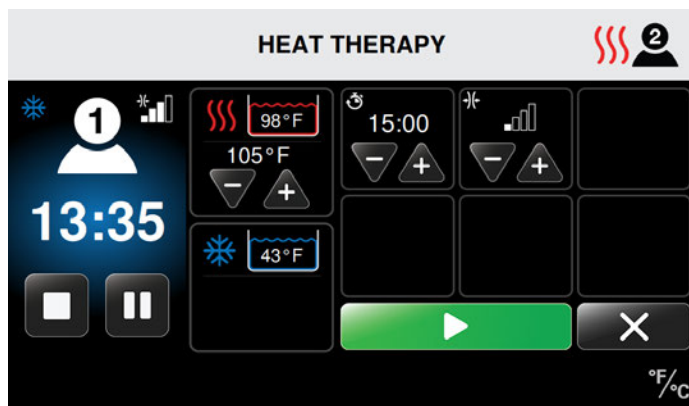

- Once you have selected the the second patient's therapy settings and the treatment temperature reaches the set point, press the Start button to begin the therapy session.
- Press the Cancel button to go back without starting the session. By returning to the previous screen, settings will not be saved.

When the session starts, the Therapy Status screen displays the session time as a countdown for the total treatment time. The screen also shows the type of therapy, treatment temperatures, the compression levels, and the reservoir temperatures and water levels. From this screen, you can stop or pause treatment.

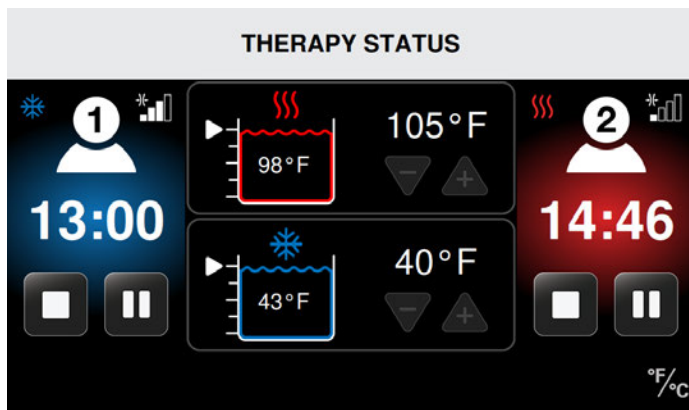

In this example:

Patient 1's session is in progress with:

- Cold Therapy
- Medium compression
- 13:00 minutes of Cold Therapy remaining
- Cold Therapy temperature is set to 40 °F (4 °C)
- Actual reservoir temperature is 43 °F (6 °C)

Patient 2's session is in progress with:

- Heat Therapy
- Low compression
- 14:46 minutes of Heat Therapy remaining
- Heat Therapy temperature set to 105 °F (41 °C)
- Actual reservoir temperature is 98 °F (37 °C)

HEAT THERAPY

The Med4 Elite allows you to set up a Heat Therapy session for each patient. Individual settings for each patient's session include treatment temperature, time and compression level.

To set up a Heat Therapy session from the Select Patient screen:

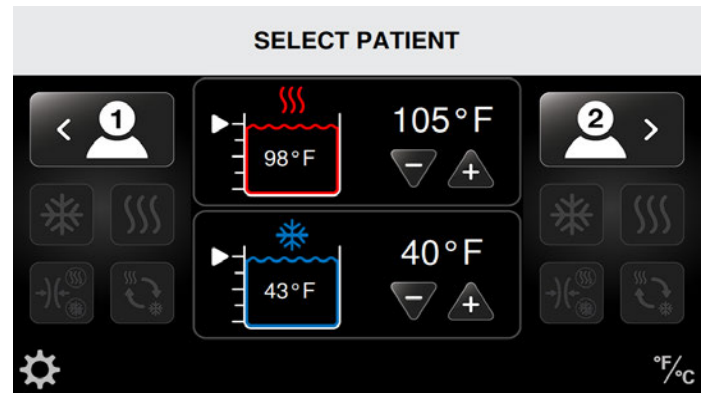

1. Select the desired patient by pressing the appropriate Patient icon: Patient 1 is on the left side of the screen or Patient 2 is on the right side of the screen.

The Select Therapy screen appears with four active therapy icons. (In this example, Patient 1 is selected.)

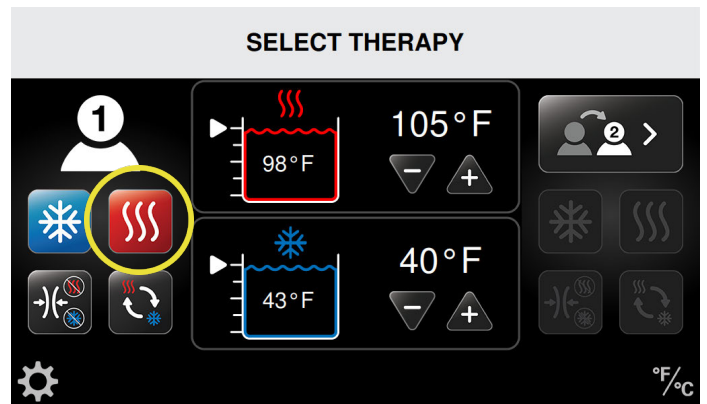

2. Press the Heat Therapy icon.

The Heat Therapy screen appears for the selected patient. This screen allows you to adjust individual settings. These include heat temperature, treatment time (in minutes) and compression level (Low or No compression) for Heat Therapy as indicated for use.

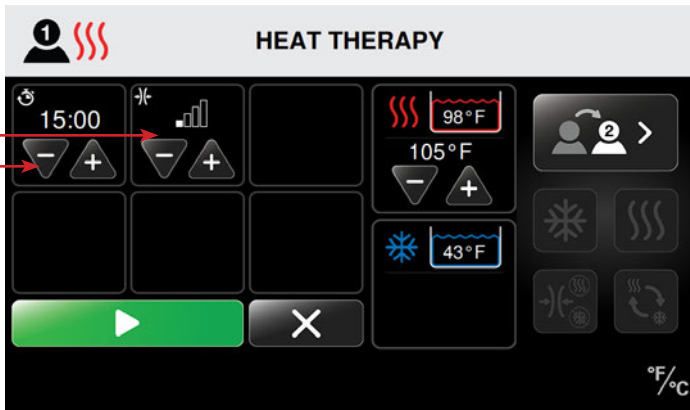

3. Press the plus (+) arrow to increase or the minus (-) arrow to decrease the treatment time for the Heat Therapy session.
4. Press the plus (+) arrow to increase or the minus (-) arrow to decrease the compression level for the Heat Therapy session.

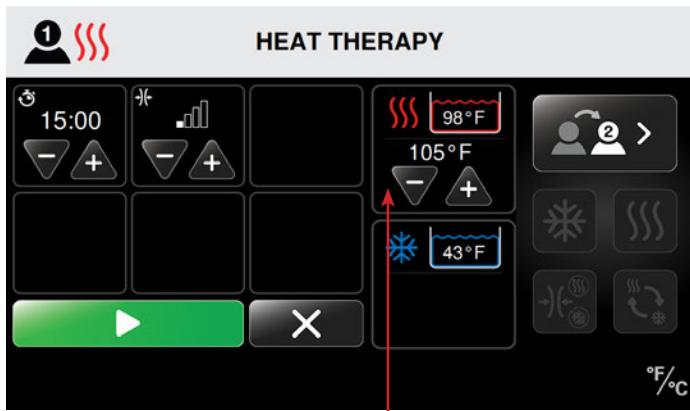
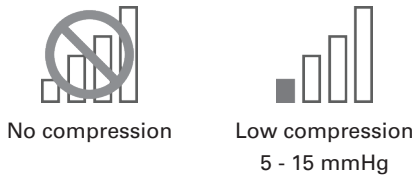

Available compression levels:

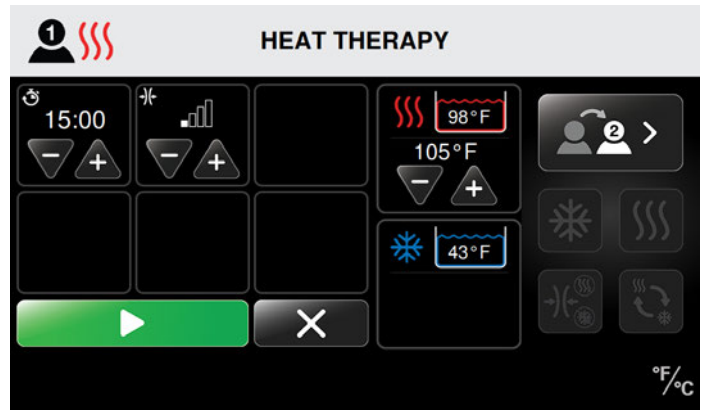

5. Press the plus (+) arrow to increase or the minus (-) arrow to decrease the treatment temperature for the Heat Therapy session.

NOTE: The water for Heat Therapy comes from a shared reservoir. Therefore, if two patients receive Heat Therapy at the same time, the temperature will be the same for both patients. Any modification to the heat setting will affect both patients.



6. Once you have selected the patient's therapy settings and the treatment temperature reaches the set point, press the  Start button to begin the therapy session.
7. Press the  Cancel button to go back to the main screen without starting the session. By returning to the main screen, settings will not be saved.

When the session starts, the Therapy Status screen displays the session time as a countdown for the total treatment time. The screen also shows the type of therapy, treatment temperatures, the compression levels, and the reservoir temperatures and water levels. From this screen, you can stop or pause treatment.

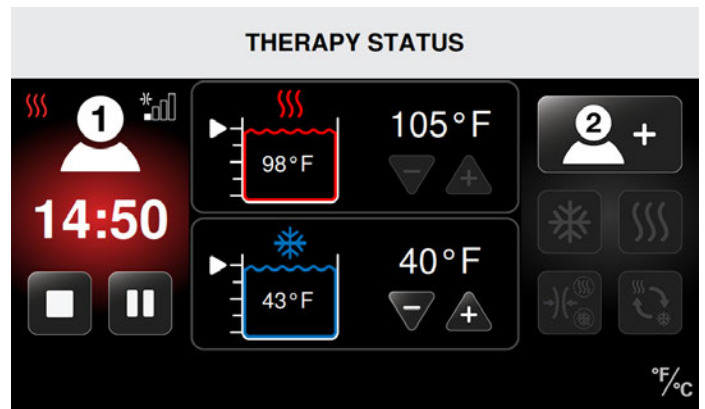

In this example, Patient 1's session is in progress with:

- Heat Therapy
- Low compression
- 14:50 minutes of Heat Therapy remaining
- Heat Therapy temperature set to 105 °F (41 °C)
- Actual reservoir temperature is 98 °F (37 °C)

COLD THERAPY

A Cold Therapy session can be set up for each patient. Individual settings for each patient's session include treatment temperature, time and compression level. Cold Therapy also includes an optional Snooze function. The Snooze function allows up to six (on/off) cycles of Cold Therapy and the ability to set the time between cycles. If a patient's therapy requires Snooze, enable this function in the System Settings. See *Configuring Med4 Elite System Settings > Setting up Defaults > Cold Settings > Snooze Function*.

To set up a Cold Therapy session from the Select Patient screen:

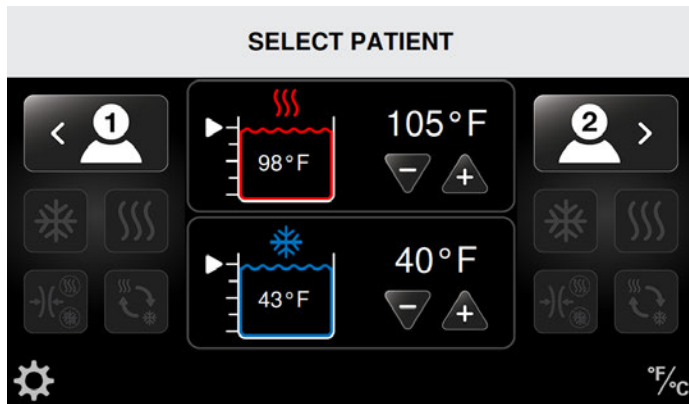

1. Select the desired patient by pressing the appropriate Patient Icon: Patient 1 is on the left side of the screen or Patient 2 is on the right side of the screen.

The Select Therapy screen appears with four active therapy icons. (In this example, Patient 1 is selected.)

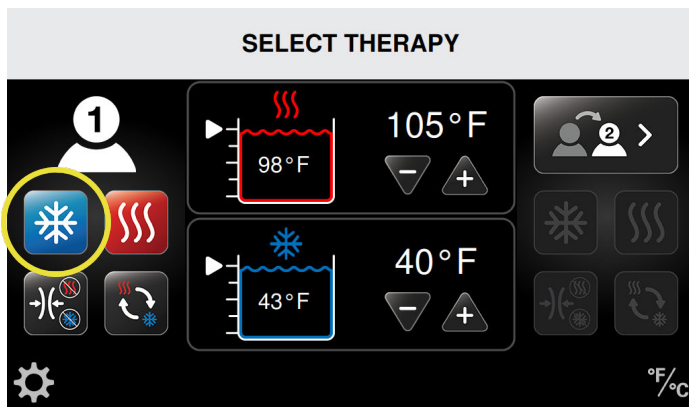

2. Press the Cold Therapy icon.

The Cold Therapy screen appears for the selected patient. This screen allows you to adjust individual settings. These include cold temperature, treatment time (in minutes), compression level (Low, Medium-low, Medium, High or No compression) and the Snooze function (if enabled).

NOTE: The following screens are shown with the Snooze function enabled. **The system's master Snooze function is disabled by default.** Before using it in Cold Therapy, remember to enable it in System Settings. See *Configuring Med4 Elite System Settings > Setting Defaults > Snooze Function*.

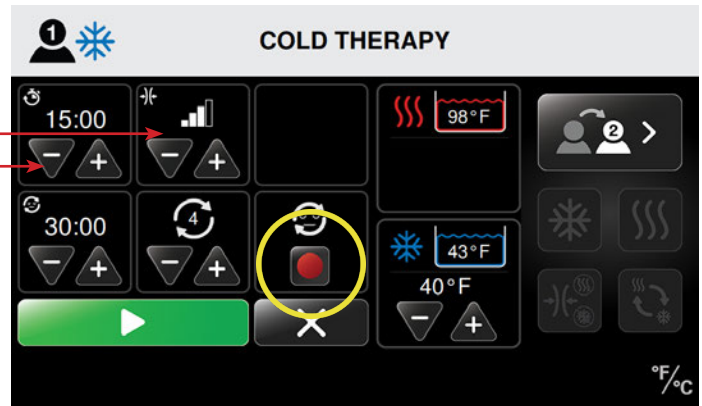

If the Snooze function is enabled, but is not desired for the patient therapy session, press the red Toggle Snooze button to disable the Snooze function for the session.

3. Press the plus (+) arrow to increase or the minus (-) arrow to decrease the treatment time (in minutes) for the Cold Therapy session.
4. Press the plus (+) arrow to increase or the minus (-) arrow to decrease the compression level for the Cold Therapy session.

Available compression levels:

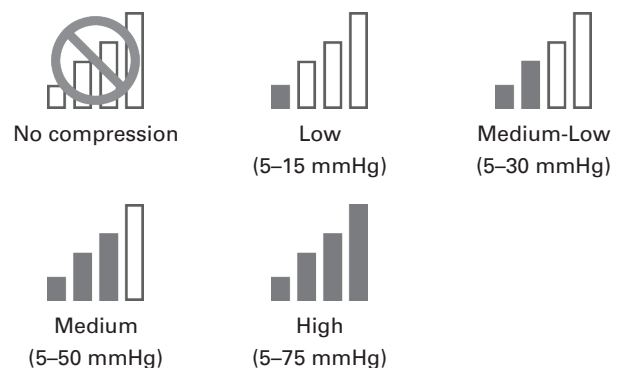

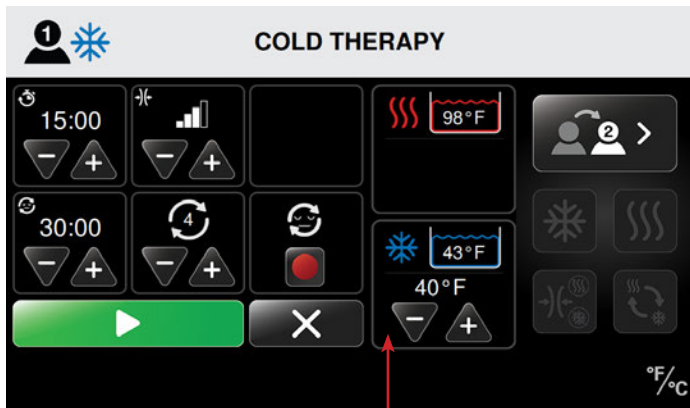

5. Press the plus (+) arrow to increase or minus arrow (-) to decrease the cold temperature for the Cold Therapy session.

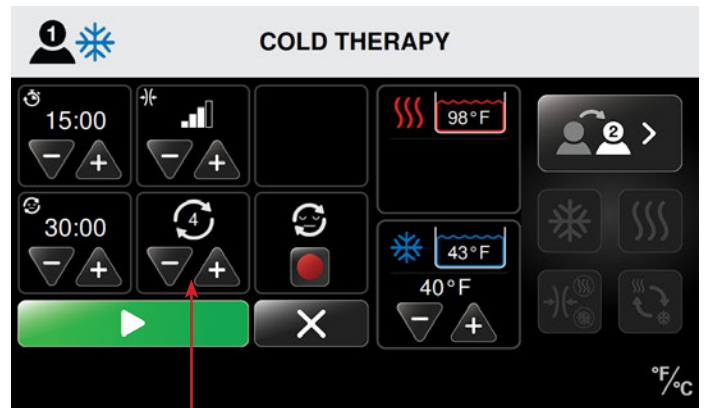

- b. Press the plus (+) arrow to increase or the minus (-) arrow to decrease the number of Cold Therapy cycles.

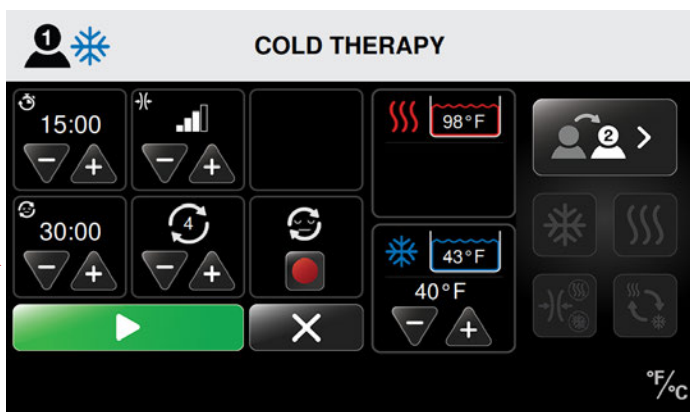



NOTE: The water for Cold Therapy comes from a shared reservoir. Therefore, if two patients receive Cold Therapy at the same time, the temperature will be the same for both patients. Any modification to the cold setting will affect both patients.

6. Set up the Snooze function.
 - a. To determine the amount of time between Cold Therapy sessions (snooze time), press the plus (+) arrow to increase or the minus (-) arrow to decrease the time.

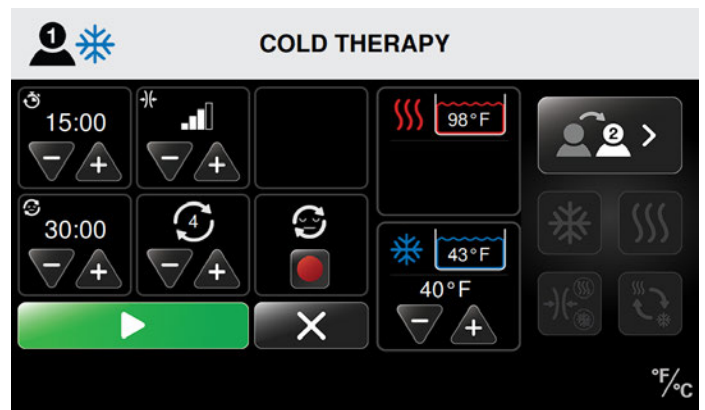
NOTE: The Med4 Elite allows you to set up a maximum of six (6) Cold Therapy cycles when Snooze is enabled. Set the maximum number of cycles to allow for individual therapy sessions in the default settings.



7. Once you have selected the patient's therapy settings and the treatment temperature reaches the set point, press the  Start button to begin the therapy session.
8. Press the  Cancel button to go back to the main screen without starting the session. By returning to the main screen, settings will not be saved.

When the session starts, the Therapy Status screen displays the session time as a countdown for the total treatment time. The screen also shows the type of therapy, treatment temperatures, the compression levels, and the reservoir temperatures and water levels. From this screen, you can stop or pause treatment.

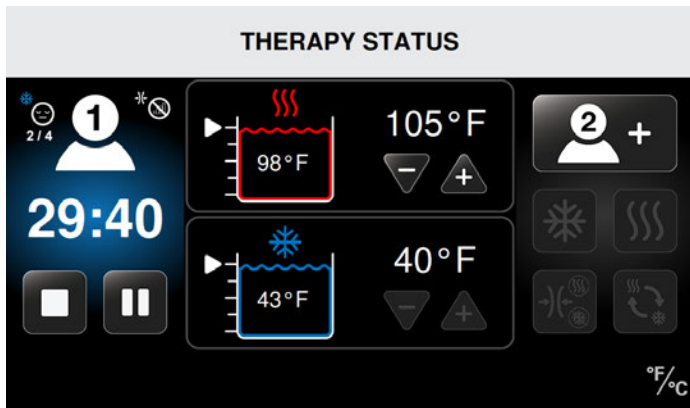

In this example, Patient 1's session is in progress with:

- Cold Therapy
- No compression
- Snooze enabled
- Snooze on cycle two of four (2 / 4)
- 29:40 minutes of total therapy session remaining
- Cold Therapy temperature set to 40 °F (4 °C)
- Actual reservoir temperature is 43 °F (6 °C)

RAPID CONTRAST THERAPY

The Med4 Elite allows you to set up a Rapid Contrast Therapy session for up to two patients. Individual settings for a patient's session include total treatment time, heat and cold treatment temperatures, times and compression levels. *To maintain desired temperatures throughout treatment, it is recommended that Rapid Contrast Therapy be used on one patient at a time.*

To set up a Rapid Contrast Therapy session from the Select Patient screen:

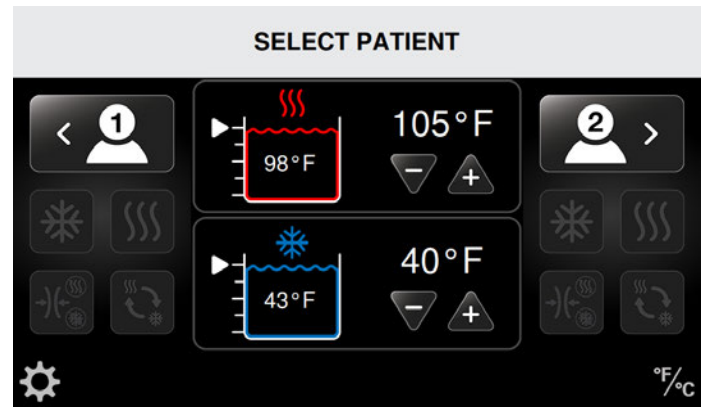

1. Select the desired patient by pressing the appropriate Patient Icon: Patient 1 is on the left side of the screen or Patient 2 is on the right side of the screen.

The Select Therapy screen appears, with four active therapy icons. (In this example, Patient 1 is selected.)

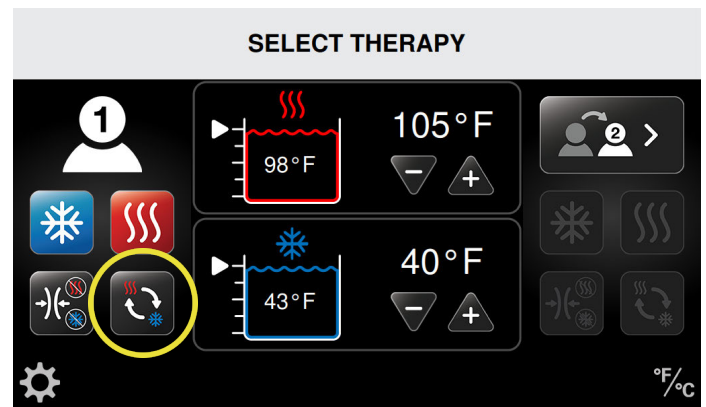

2. Press the Rapid Contrast icon.

The Rapid Contrast Therapy screen appears for the selected patient. This screen allows you to adjust individual settings. These include heat temperature, cold temperature, heat and cold therapy treatment times and total treatment time (in minutes) and compression levels (Cold: Low, Medium-low, Medium, High or No compression/Heat: Low or No compression).

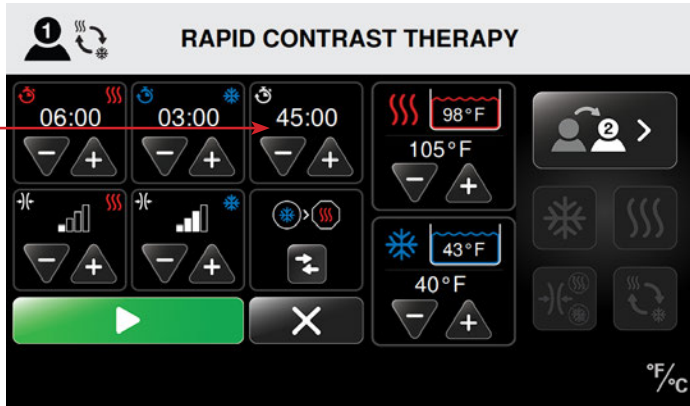

3. Press the plus (+) arrow to increase or the minus (-) arrow to decrease the total treatment time (in minutes) for the Rapid Contrast Therapy session.

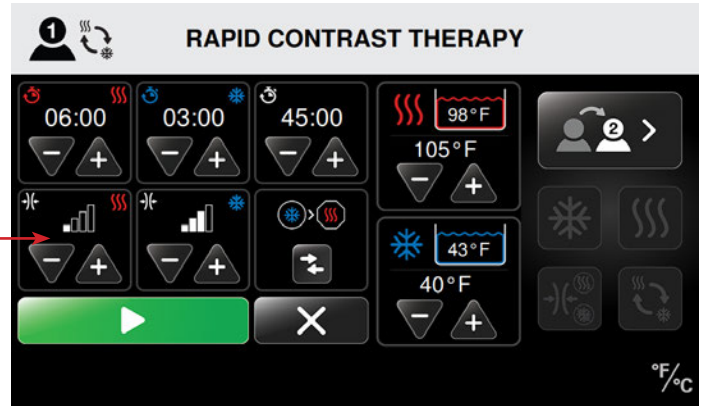

5. Press the plus (+) arrow to increase or the minus (-) arrow to decrease the compression level for the Heat Therapy portion of the Rapid Contrast Therapy session.

HEAT TREATMENT IN RAPID CONTRAST THERAPY

To set up the Heat Therapy treatment in Rapid Contrast Therapy:

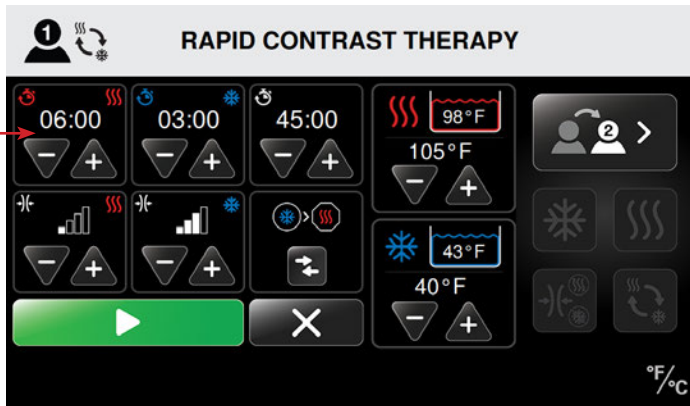

4. Press the plus (+) arrow to increase or the minus (-) arrow to decrease the treatment time (in minutes) for the Heat Therapy portion of the Rapid Contrast Therapy session.

Available compression levels:



No compression

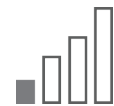

Low compression
5 - 15 mmHg

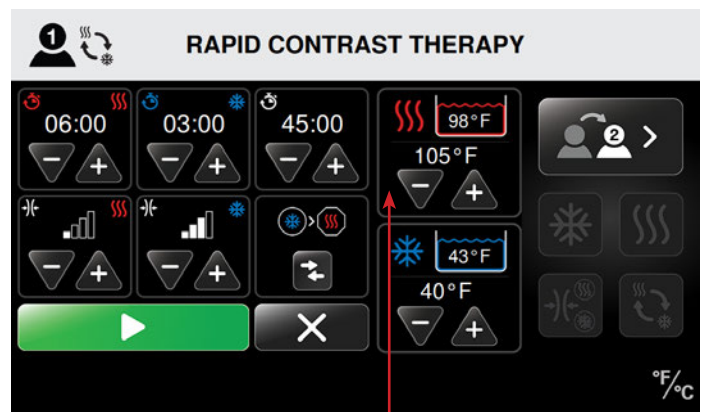

6. Press the plus (+) arrow to increase or the minus (-) arrow to decrease the heat temperature for the Rapid Contrast Therapy session.

NOTE: The water for Heat Therapy comes from a shared reservoir. Therefore, if two patients receive Heat Therapy at the same time, the temperature will be the same for both patients. Any modification to the heat setting will affect both patients.

COLD TREATMENT IN RAPID CONTRAST THERAPY

To set up the Cold Therapy treatment in Rapid Contrast Therapy:

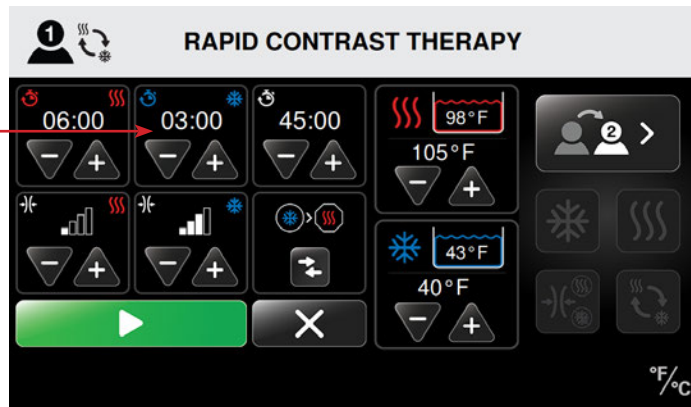

- Press the plus (+) arrow to increase or the minus (-) arrow to decrease the treatment time (in minutes) for the Cold Therapy portion of the Rapid Contrast Therapy session.

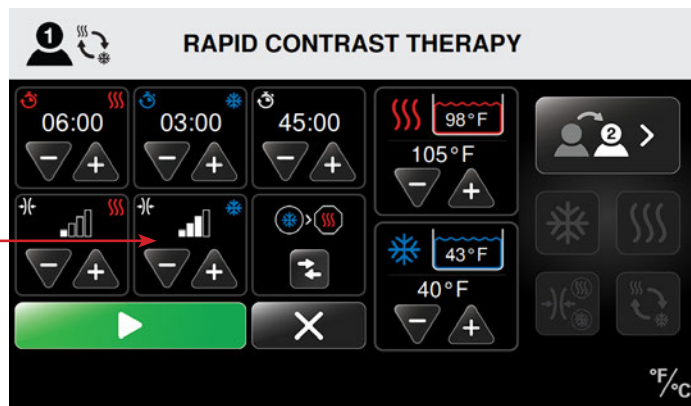

- Press the plus (+) arrow to increase or the minus (-) arrow to decrease the compression level for the cold therapy portion of the Rapid Contrast Therapy session.

Available compression levels:

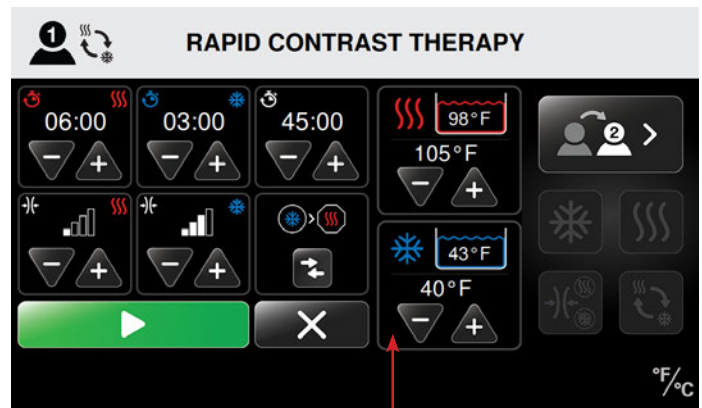
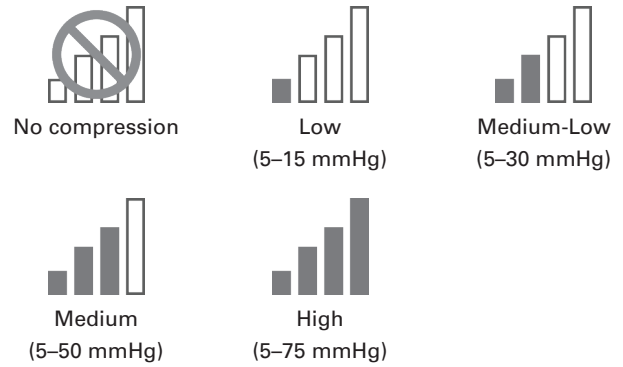



- Press the plus (+) arrow to increase or the minus (-) arrow to decrease the cold temperature for the Rapid Contrast Therapy session.

NOTE: The water for Cold Therapy comes from a shared reservoir. Therefore, if two patients receive Cold Therapy at the same time, the temperature will be the same for both patients. Any modification to the cold setting will affect both patients.

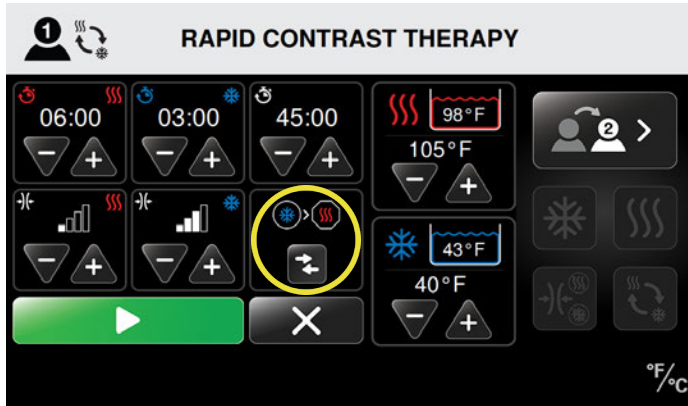
SETTING THE STARTING AND ENDING THERAPY IN RAPID CONTRAST THERAPY



- Use the  Set Beginning Therapy button to start Rapid Contrast Therapy with Cold or Heat treatment. The therapy icon shown within the circle indicates the treatment that will begin your Rapid Contrast Therapy session. The therapy icon shown within the octagon indicates the treatment that will end your session.
- To control which therapy treatment the session ends on, you may increase or decrease total treatment time, or Heat or Cold Therapy times. The ending icon will adjust accordingly.
- Once you have selected the patient's therapy settings and the treatment temperature reaches the set point, press the  Start button to begin the therapy session.
- Press the  Cancel button to go back to the main screen without starting the session. By returning to the main screen, settings will not be saved.

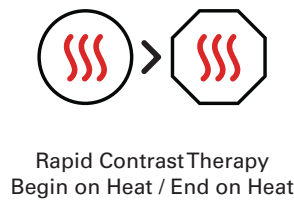
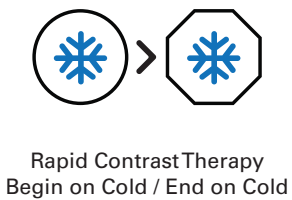
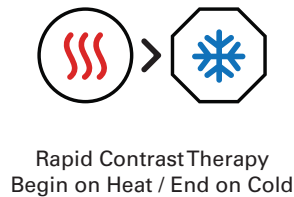

When the session starts, the Therapy Status screen displays the session time as a countdown for the total treatment time. The screen also shows the type of therapy, treatment temperatures, the compression levels, and the reservoir temperatures and water levels. From this screen, you can stop or pause treatment.

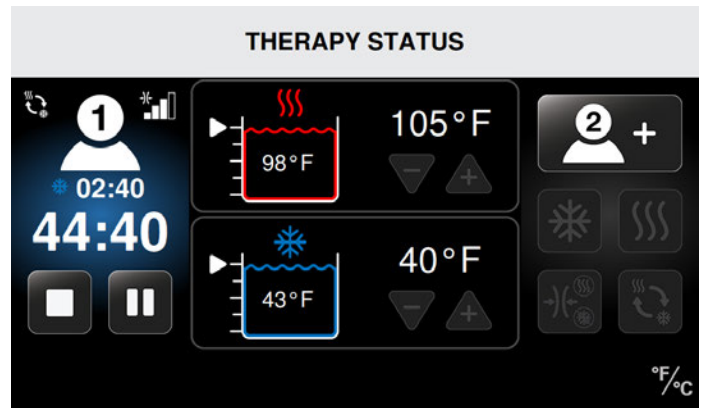

In this example, Patient 1's session is in progress with:

- Rapid Contrast Therapy
- 44:40 minutes remaining in the Rapid Contrast Therapy session
- Cold Therapy is in progress
- 2:40 minutes remaining in the current portion of Cold Therapy
- Medium compression for Cold Therapy
- Heat temperature set to 105 °F (41 °C)
- Actual reservoir temperature is 98 °F (37 °C)
- Cold temperature set to 40 °F (4 °C)
- Actual reservoir temperature is 43 °F (6 °C)

COMPRESSION-ONLY THERAPY

The Med4 Elite allows you to set up a Compression-Only Therapy session for each patient. Compression-Only Therapy sessions only provide compression, no Heat or Cold therapy.

To set up a Compression-Only Therapy session from the Select Patient screen:

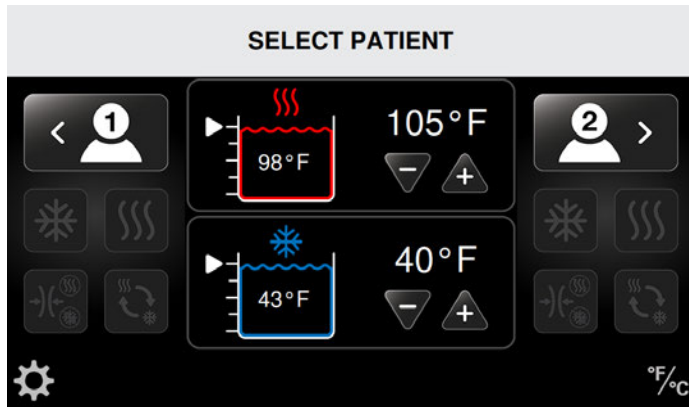

1. Select the desired patient by pressing the appropriate Patient Icon: Patient 1 is on the left side of the screen or Patient 2 is on the right side of the screen.

The Select Therapy screen appears with four active therapy icons. (In the following example, Patient 1 is selected.)

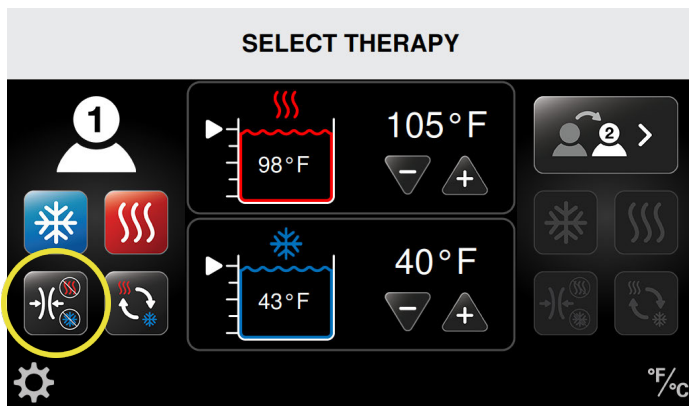

2. Press the Compression Therapy icon.

The Compression-Only Therapy screen appears for the selected patient. This screen allows you to adjust individual settings. These include treatment time (in minutes) and the compression level.

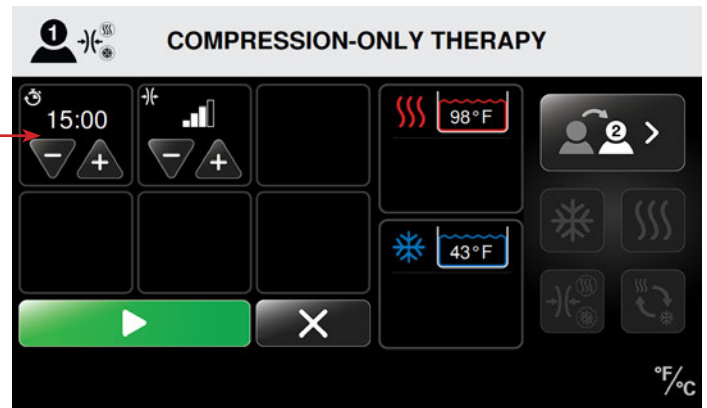

3. Press the plus (+) arrow to increase or the minus (-) arrow to decrease the treatment time (in minutes) for the Compression Therapy session.

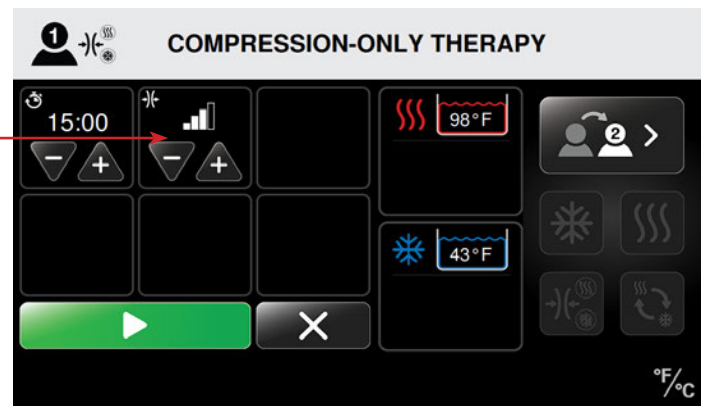

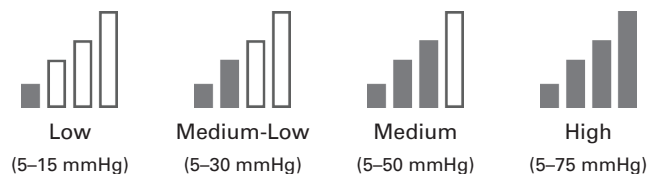

4. Press the plus (+) arrow to increase or the minus (-) arrow to decrease the compression level for the Compression Therapy session.

Available compression levels:

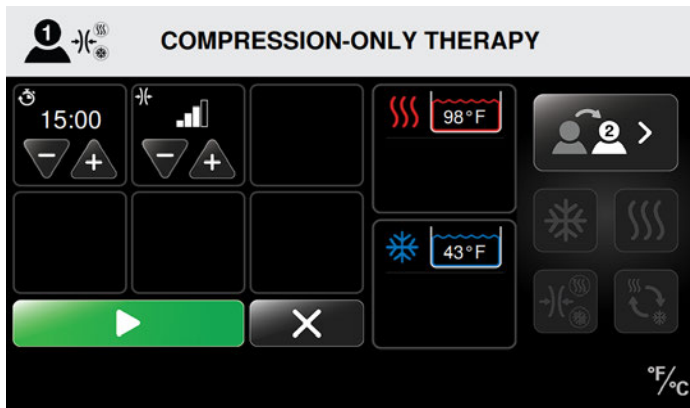



5. Once you have selected the patient's therapy settings and the treatment temperature reaches the set point, press the  Start button to begin the therapy session.
6. Press the  Cancel button to go back to the main screen without starting the session. By returning to the main screen, settings will not be saved.

When the session starts, the Therapy Status screen displays the session time as a countdown for the total treatment time. The screen also shows the compression level. From this screen, you can stop or pause treatment.

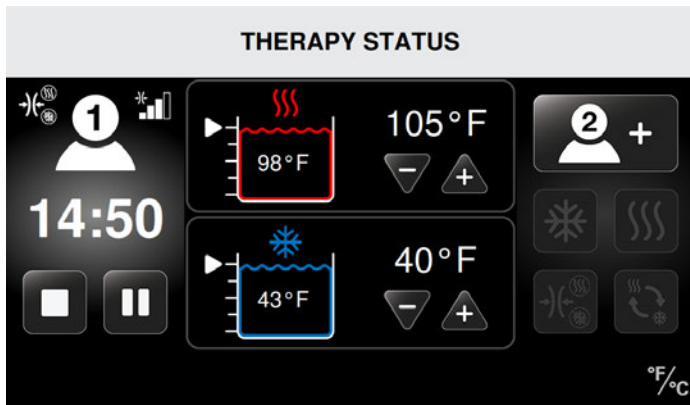

In this example, Patient 1's session is in progress with:

- Compression-Only Therapy
- Medium compression
- 14:50 minutes remaining of Compression-Only Therapy



PAUSING, CHANGING, AND STOPPING A THERAPY

PAUSING

The Med4 Elite allows you to pause a therapy session at any time.

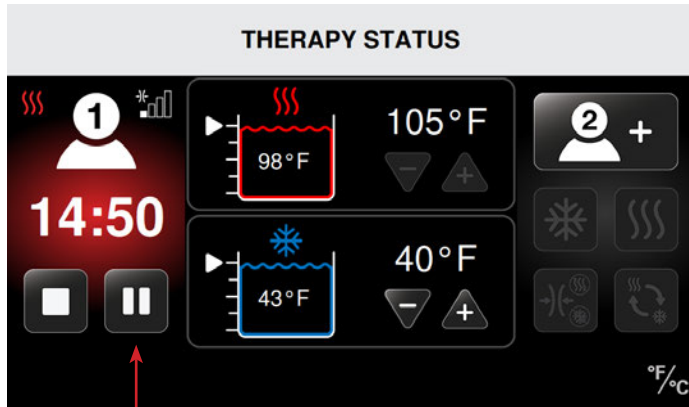
NOTE: Heat Therapy is used in the following illustrations to show how to pause a therapy in progress. These procedures can be used to pause in Cold, Rapid Contrast and Compression-Only Therapies.



1. From the Therapy Status screen, press the  Pause button. The therapy session pauses.
2. To resume the paused therapy without any adjustments, press the  Start button.

CHANGING

You may change therapy session settings only while treatment is paused. To make changes, first pause the therapy, as described in the previous section, *Pausing*.

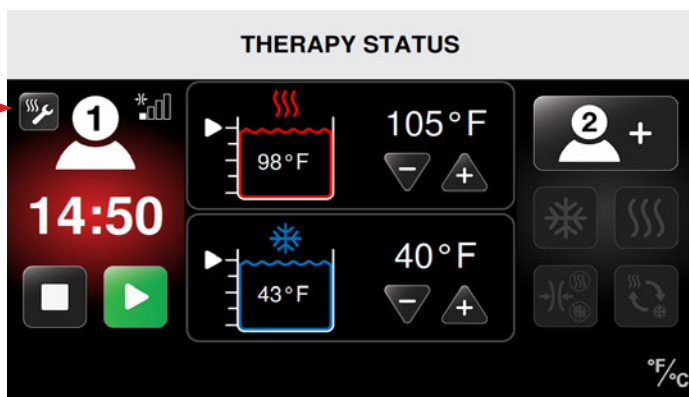

1. Once the therapy is paused, press the  Adjust Therapy Settings icon.

The Heat Therapy settings screen appears after pressing the Adjust Therapy Settings icon.

In the following example, Patient 1's Heat Therapy session was modified with a reduced time setting.



2. Press the plus (+) arrow to increase or the minus (-) arrow to decrease the time, compression level, or temperature setting(s) for the current session.
3. When you are ready to resume the session, press the  Start button.

The Therapy Status screen displays the new therapy settings and the therapy session will continue.

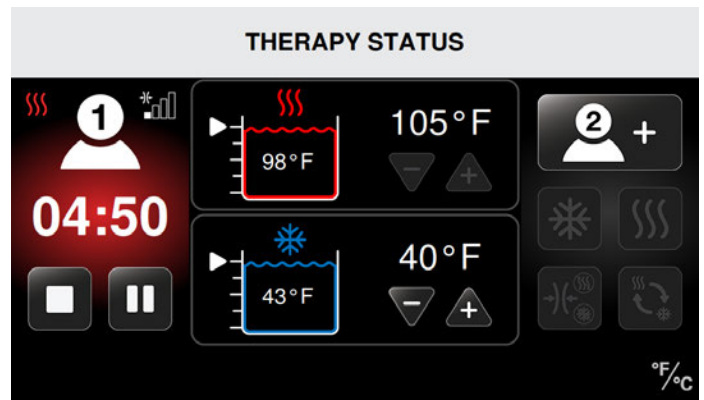

1. Once the therapy is paused, press the  Adjust Therapy Settings icon.

STOPPING

The Med4 Elite allows you to stop a therapy session at any time. By pressing the Stop button, all therapy settings will reset to the default settings and new therapy settings must be selected.

To stop a therapy session:

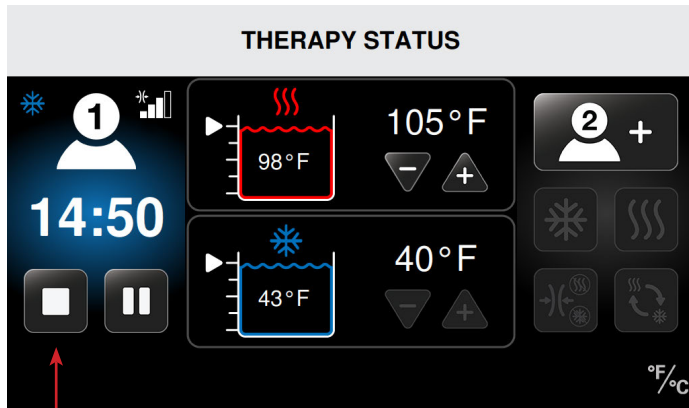

1. Press the  Stop button in the Therapy Status screen.

The therapy session stops and the Select Patient screen appears. The previous therapy settings cannot be adjusted. A new therapy session can then be started with new settings.

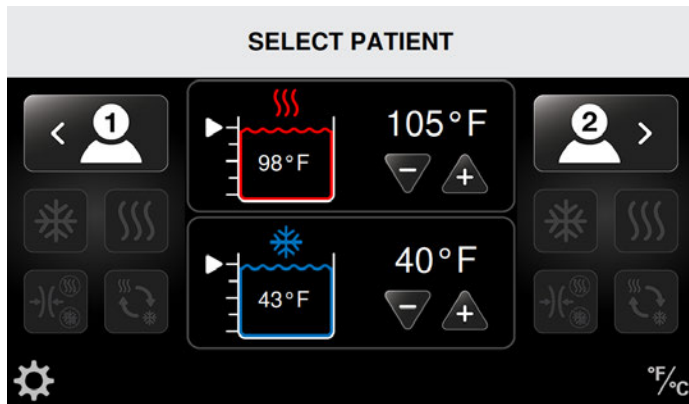

For setting up new therapies, refer to the procedures in the appropriate section in *Using the Med4 Elite*:

- *Heat Therapy*
- *Cold Therapy*
- *Rapid Contrast Therapy*
- *Compression-Only Therapy*

END OF THERAPY

When the time remaining for a therapy reaches zero, the Select Patient screen appears. The Therapy Status screen will remain on the touch-screen if a second therapy is still in progress.

A single end of therapy tone will play indicating the therapy is finished for Patient 1. The same end of therapy tone will play twice indicating the therapy is finished for Patient 2.

POWERING DOWN

To power down the Med4 Elite, use any of the following methods:

1. By pressing and holding the green On/Off button located above the touch screen.

NOTE: If powering down the Control Unit while a therapy is still in progress, all therapy will be stopped automatically.

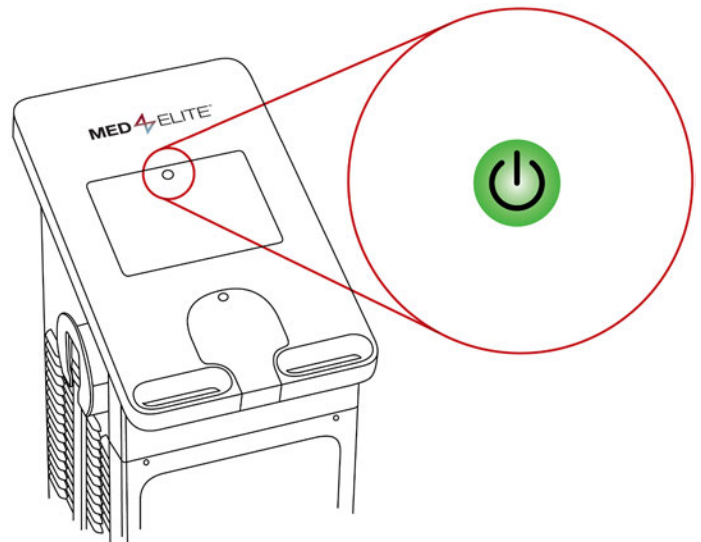

2. By switching the On/Off switch on the back of the Control Unit to the Off position.
3. If the On/Off button and the On/Off switch are not working properly, you may power down the Control Unit by carefully detaching the power cord from the back.

To power the Med4 Elite up after it has been powered down, ensure the power cord is properly attached to the back of the Control Unit and into an appropriate wall outlet, that the power switch is switched to on, and then press the amber On/Off button.

NOTE: The Med4 Elite will automatically power down after six (6) hours of inactivity.

CONFIGURING MED4 ELITE SYSTEM SETTINGS

The Med4 Elite allows you to change the factory settings and to customize the default settings through System Settings.

PERSONAL IDENTIFICATION NUMBER (PIN)

For security, the Med4 Elite requires users to enter a PIN before accessing System Settings. **The factory default PIN is 1111**, however, you can change the PIN at any time.

IMPORTANT: If you lose or forget your PIN, call Game Ready Technical Support and request a Master PIN. This will allow you to access the System Settings to configure a new PIN. You can contact Game Ready Technical Support at 1.888.426.3732 (1.888.GameReady) and +1.510.868.2100. From outside the U.S., contact your local distributor.

CHANGING THE PIN

To change the PIN:

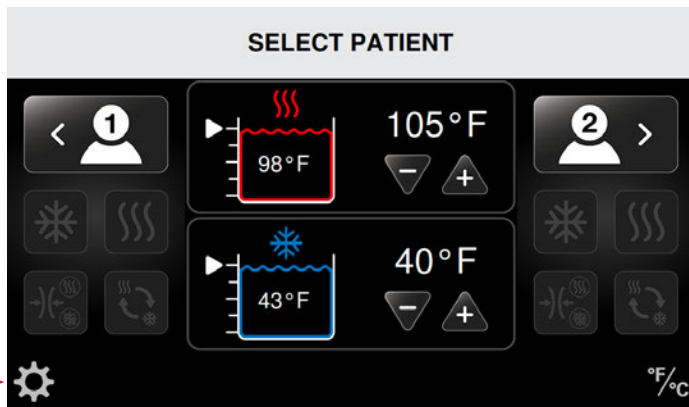

1. Press the System Settings icon located in the bottom left corner of the Select Patient screen.

The Enter Pin screen appears.

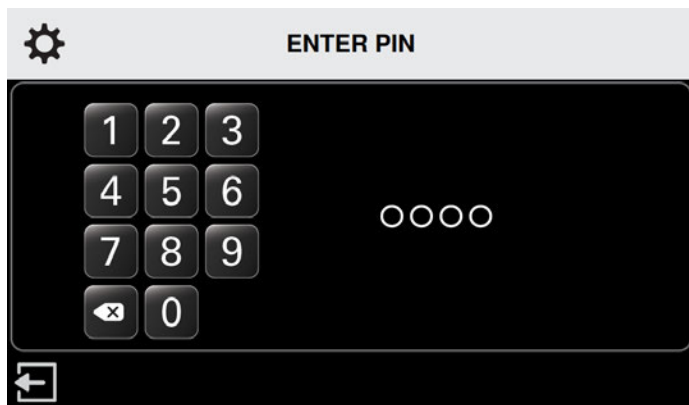

2. Press 1111 (the factory default PIN), or the current PIN.

The System Settings screen appears.

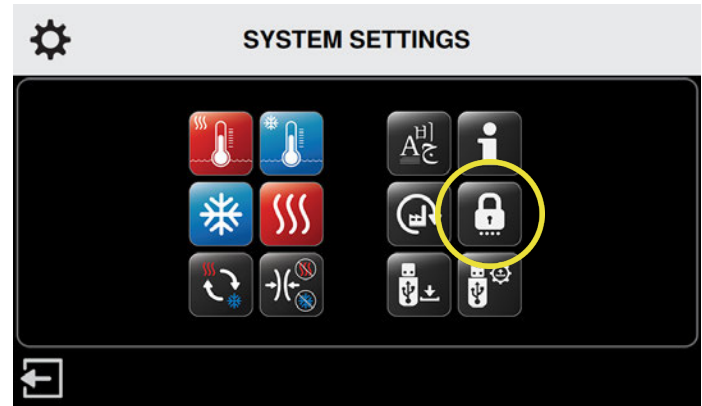

3. Press the security icon.

The Enter Current PIN screen appears.

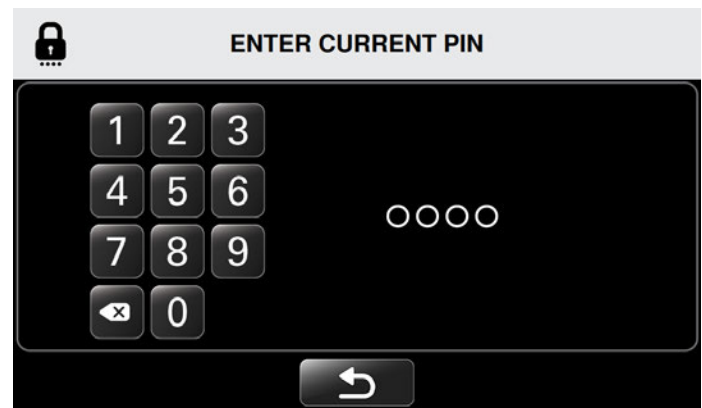

4. Press 1111 (the factory default PIN), or the current PIN.

The Enter New PIN screen appears.

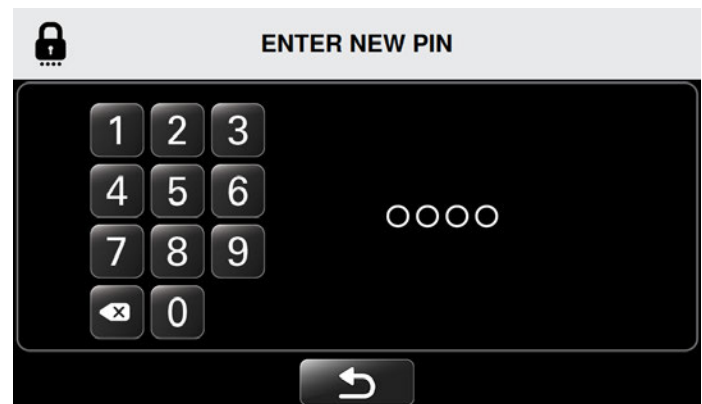

5. Press the desired numbers to enter the new four-digit PIN.

NOTE: To return to System Settings without changing the PIN, press the  Return button.

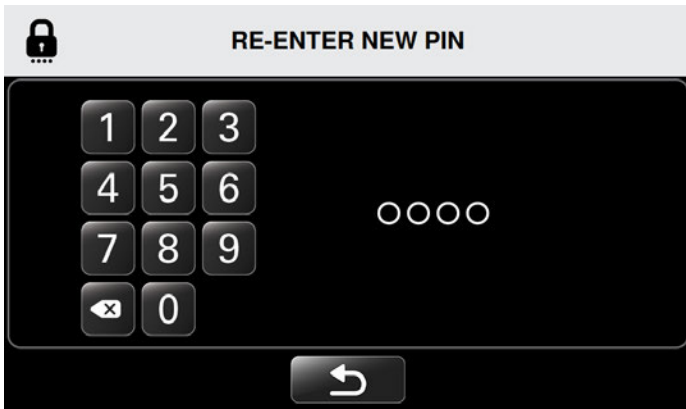

The Re-enter New PIN screen appears.

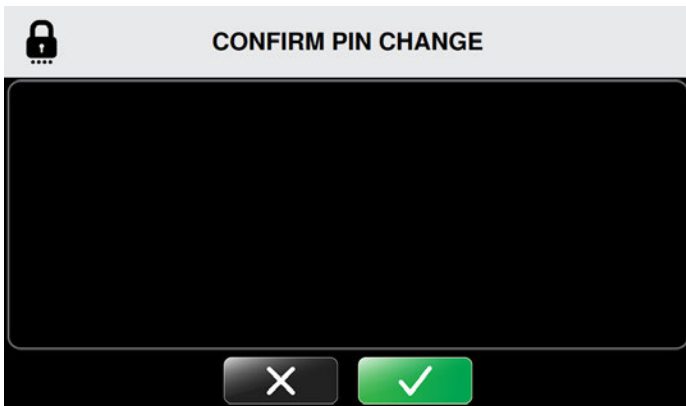

6. Re-enter the new PIN to confirm.

The Confirm PIN Change screen appears.



7. To confirm PIN change, press the  Confirm button.
8. To cancel the PIN change, press the  Cancel button.

Upon confirmation, the System Settings screen returns, allowing you to change other settings.

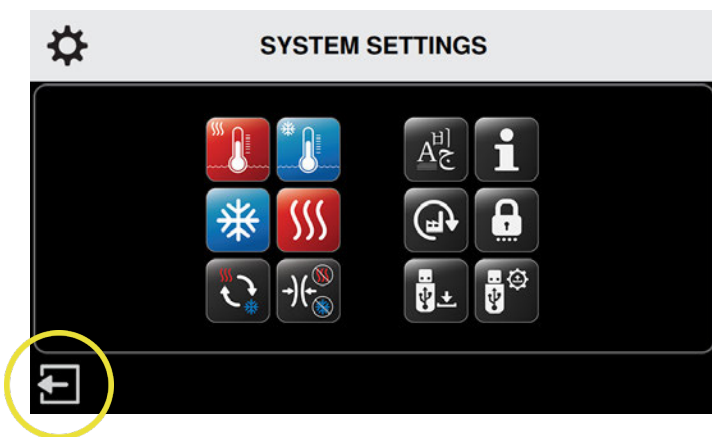

9. If no other changes are required, press the  Exit icon to save the new settings. Please remember to keep your PIN secure and accessible. The PIN is necessary to access System Settings and to change default settings.

SETTING DEFAULTS





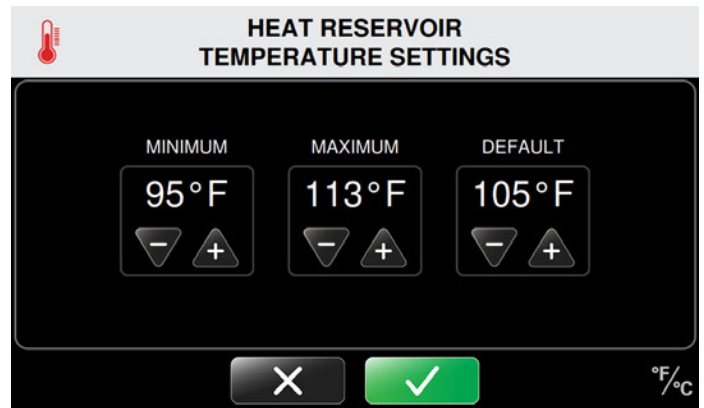





Default settings define the minimum, maximum and default therapy temperatures, therapy compression levels, and treatment time. You can use the Med4 Elite with factory settings, or change these settings at any time.











The Heat Reservoir Temperature Settings screen is shown below as an example of how to set defaults.



1. To set Minimum Defaults: Press the plus (+) arrow to increase and the minus (-) arrow to decrease the temperature to select the minimum allowable therapy setting. In the example above, the minimum allowable temperature when a Heat Therapy session is set-up will be 95 °F. Users will not be able to set a heat therapy temperature lower than 95 °F.
2. To set Maximum Defaults: Press the plus (+) arrow to increase and the minus (-) arrow to decrease the temperature to select the maximum allowable therapy setting. In the example above, the maximum allowable temperature when a Heat Therapy session is set-up will be 113 °F. Users will not be able to set a heat therapy temperature higher than 113 °F.
3. To set Defaults: Press the plus (+) arrow to increase and the minus (-) arrow to decrease the temperature to select the default therapy setting. In the example above, the default temperature when a Heat Therapy session is set-up will be 105 °F. This is the temperature setting that first appears in the Heat Therapy screen when a Heat Therapy session is being configured. Users can customize this temperature for specific therapy sessions, but not outside the range set in the minimum and maximum settings above.

A complete listing of all factory settings is shown on the following pages.

FACTORY DEFAULT SETTINGS			
	Minimum Setting	Maximum Setting	Default Setting
Reservoir Temperature			
 Heat	95 °F / 35 °C	113 °F / 45 °C	105 °F / 41 °C
 Cold	38 °F / 3 °C	60 °F / 16 °C	45 °F / 7 °C
Heat Therapy			
 Compression Level	None	Low	None
 Treatment Time	5 minutes	30 minutes	15 minutes
Cold Therapy			
 Compression Level	None	High	None
 Treatment Time	5 minutes	60 minutes	15 minutes
 Snooze	Disabled	Enabled	Disabled
When Snooze is Enabled:			
 Snooze Duration	30 minutes	60 minutes	30 minutes
 Number of Snooze Cycles	2	6	4
Compression Therapy			
 Level	Low	High	Low
 Treatment Time	5 minutes	60 minutes	15 minutes

FACTORY DEFAULT SETTINGS			
	Minimum Setting	Maximum Setting	Default Setting
 Rapid Contrast Therapy			
 Heat Treatment Time	1 minute	10 minutes	3 minutes
 Cold Treatment Time	1 minute	10 minutes	3 minutes
 Total Treatment Time	15 minutes	90 minutes	30 minutes
 Hot Compression	None	Low	None
 Cold Compression	None	High	None
 Set Beginning Therapy	—	—	Cold
 Temperature			
 Degree Scale	—	—	°F
 Language	—	—	English

ACCESSING SYSTEM SETTINGS

To change default settings, enter System Settings from the Select Patient screen:

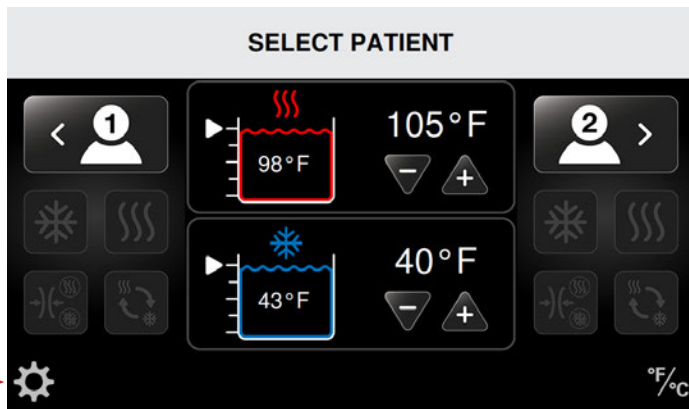

1. Press the System Settings icon located in the bottom left corner of the Select Patient screen.

The Enter Pin screen appears.

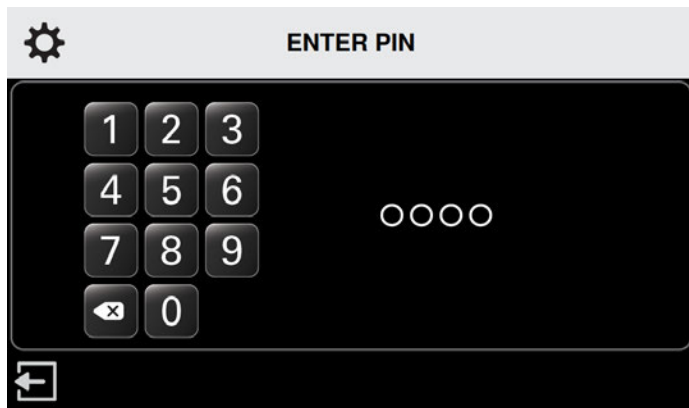

2. Use the keypad to enter your PIN.

You can now use the System Settings interface to change the system settings of your Med4 Elite.

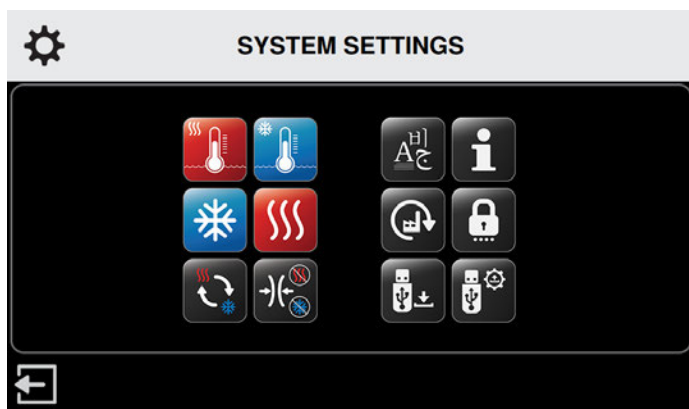

HEAT SETTINGS

The Med4 Elite enables you to define the following Heat Therapy default settings:

- Minimum and maximum default temperatures
- Minimum, maximum and default therapy session times
- Compression settings: Low and No compression

These settings determine the limits the Med4 Elite can be set for individual therapy sessions.

HEAT TEMPERATURE SETTINGS

To set up the default temperature settings for Heat Therapy:

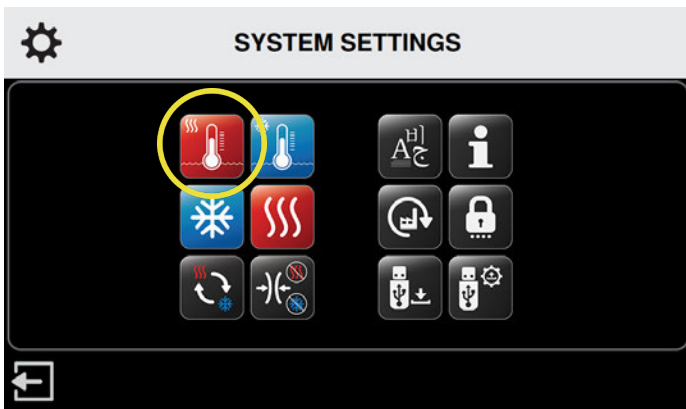

1. From the System Settings screen, press the Heat Temperature icon

The Heat Reservoir Temperature Settings screen appears.

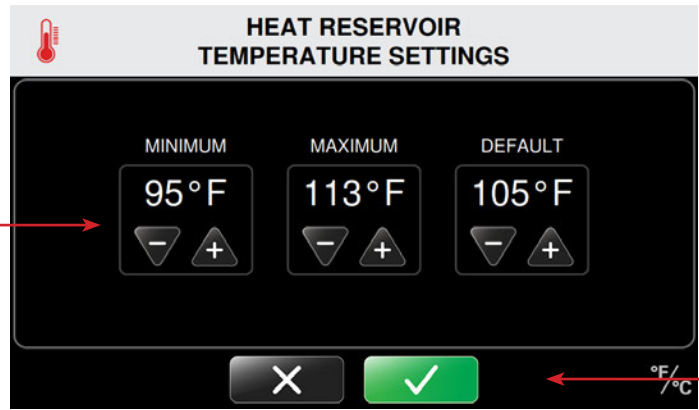

This screen allows you to control minimum, maximum and default heat temperature settings.

NOTE: The Control Unit has factory settings set at minimum heat 95 °F / 35 °C and maximum heat 113 °F / 45 °C. The default heat setting is set at 105 °F / 41 °C.





2. Press the plus (+) arrows to increase or minus arrows (-) to decrease the minimum, maximum, and default heat temperatures for therapy treatments.

When Heat Therapy mode is selected for a therapy, the Control Unit will default to the temperature set.

3. To confirm the default heat reservoir settings, press the  Confirm button.
4. To cancel these settings, press the  Cancel button.

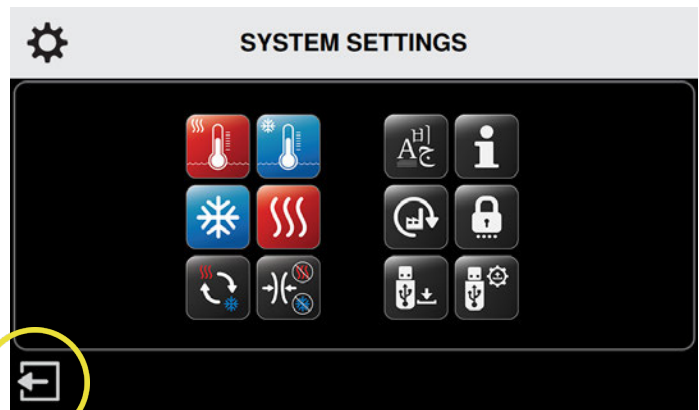
Upon confirmation, the System Settings screen returns, allowing you to change other default settings.



5. When you have made all desired changes, press the  Exit icon to save the system settings.

The Control Unit's computer powers down.

6. Press the On/Off button located at the top of the touch screen to restart the computer.

HEAT TIME SETTINGS

To set up the default time settings for Heat Therapy:

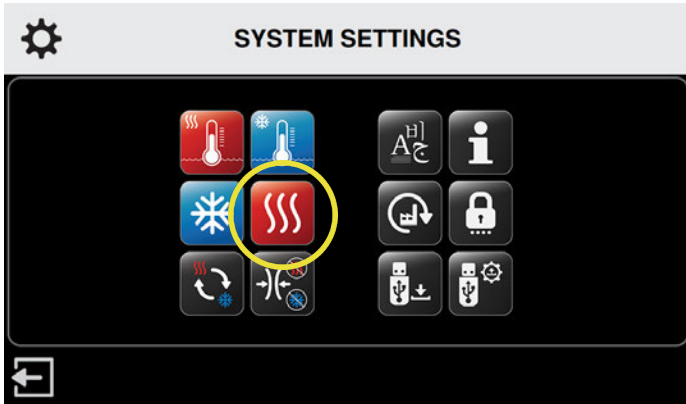

1. From the System Settings screen, press the Heat Settings icon.

The Heat Therapy Settings screen appears.

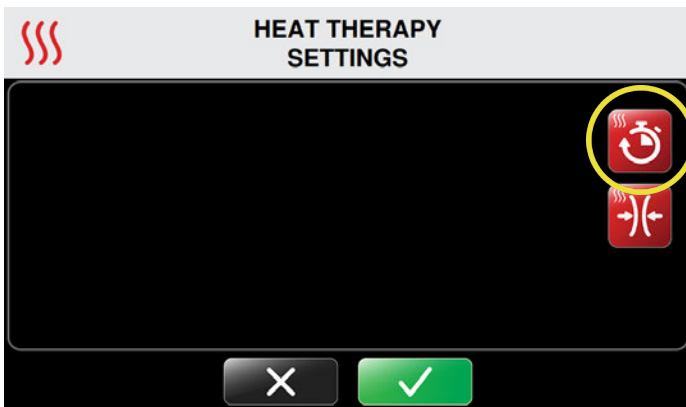

2. Press the Heat Time icon in the upper right hand corner of the screen.

The Heat Therapy Time Settings screen appears.

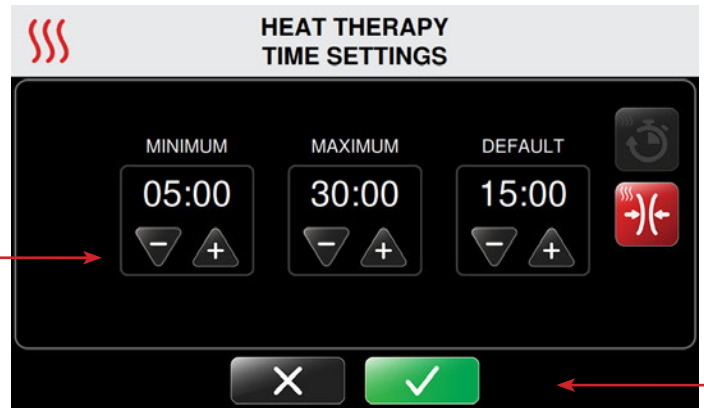

This screen allows you to control minimum, maximum and default heat session time settings. Times are set in five minute increments displayed in minutes: seconds.

NOTE: The Control Unit has factory time settings set at minimum 5 minutes and maximum 30 minutes. The default time setting is set at 15 minutes.





3. Press the plus (+) arrows to increase or minus arrows (-) to decrease the minimum, maximum and default heat time settings for therapy treatments.

When Heat Therapy mode is selected for a therapy, the Control Unit will default to the time set.

4. To confirm the default heat time settings, press the  Confirm button.
5. To cancel these settings, press the  Cancel button.

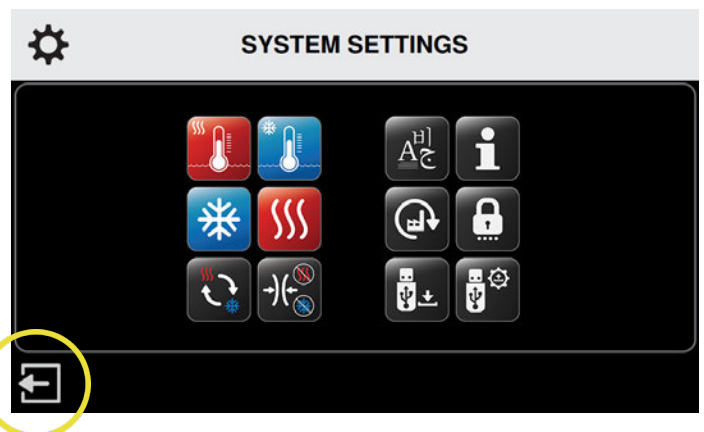
Upon confirmation, the System Settings screen returns, allowing you to change other system settings.



6. When you have made all desired changes, press the  Exit icon to save the system settings.

The Control Unit's computer powers down.

7. Press the On/Off button located at the top of the touch screen to restart the computer.

HEAT COMPRESSION SETTINGS

To set up the default compression settings for Heat Therapy:

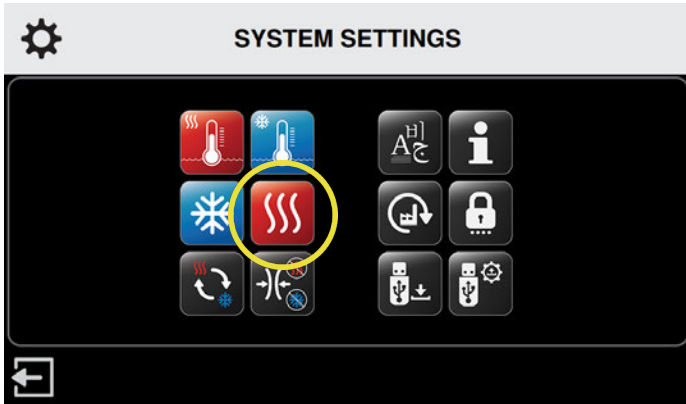

1. From the System Settings screen, press the Heat Settings icon.

The Heat Therapy Settings screen appears.

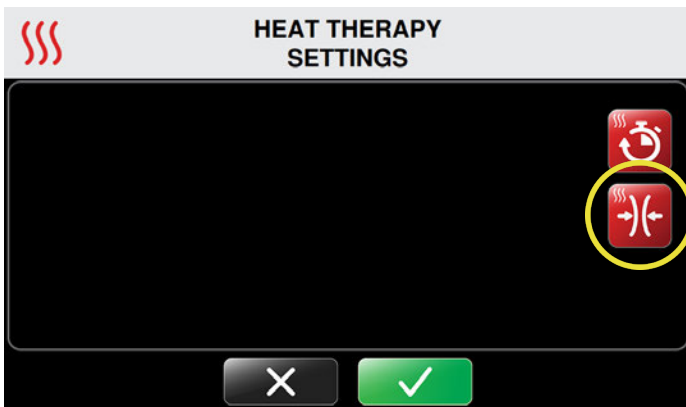

2. Press the Heat Compression icon on the right hand side of the screen.

The Heat Therapy Compression Settings screen appears.

This screen allows you to control the maximum heat compression setting. The minimum and default settings are set to No compression and cannot be changed. This ensures that No compression is always an option for individual sessions.

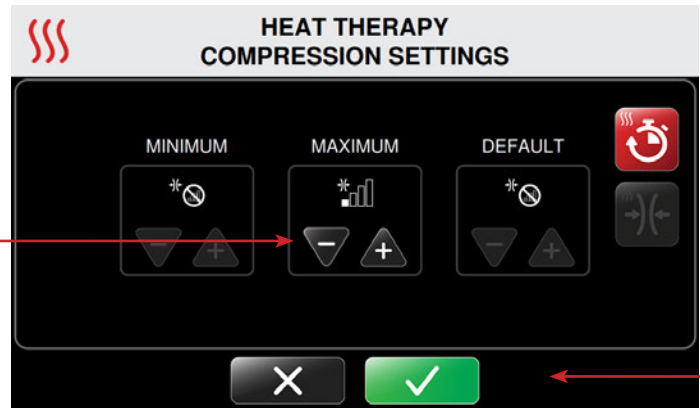

NOTE: The Med4 Elite has a maximum setting of Low compression, as indicated for use with Heat Therapy. This setting cannot be exceeded.

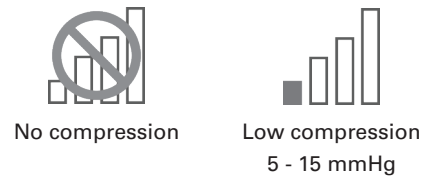

3. Under the maximum setting, press the minus (-) arrow to disabled or plus arrow (+) to set to Low compression for therapy treatments.

Available compression levels:



4. To confirm the default heat compression settings, press the  Confirm button .
5. To cancel these settings, press the  Cancel button.

Upon confirmation, the System Settings screen returns, allowing you to change other system settings.

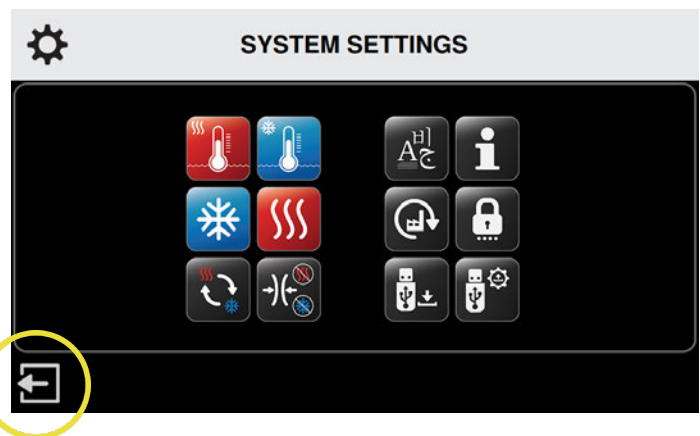

6. When you have made all desired changes, press the  Exit icon to save the system settings.

The Control Unit's computer powers down.

7. Press the On/Off button located at the top of the touch screen to restart the computer.

COLD SETTINGS

The Med4 Elite enables you to define the following Cold Therapy default settings:

- Minimum and maximum default temperatures
- Minimum, maximum and default therapy session times
- Compression settings: Low, Medium-low, Medium, High and No compression
- Enable/disable snooze
- Minimum, maximum and default snooze cycle times

These settings determine the limits the Med4 Elite can be set for individual therapy sessions.

COLD TEMPERATURE SETTINGS

To set up the default temperature settings for Cold Therapy:

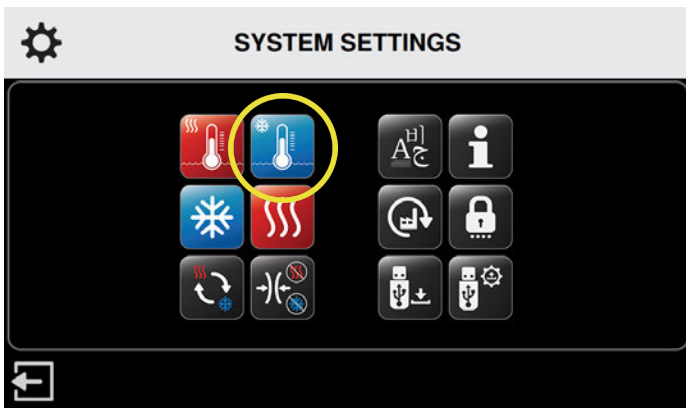

1. From the System Settings screen, press the Cold Temperature icon

The Cold Reservoir Temperature Settings screen appears.

This screen allows you to control minimum, maximum and default cold temperature settings.

NOTE: The Control Unit factory settings are set to a minimum cold of 38 °F / 3 °C and maximum cold of 60 °F / 16 °C. The default cold setting is set at 45 °F / 7 °C.

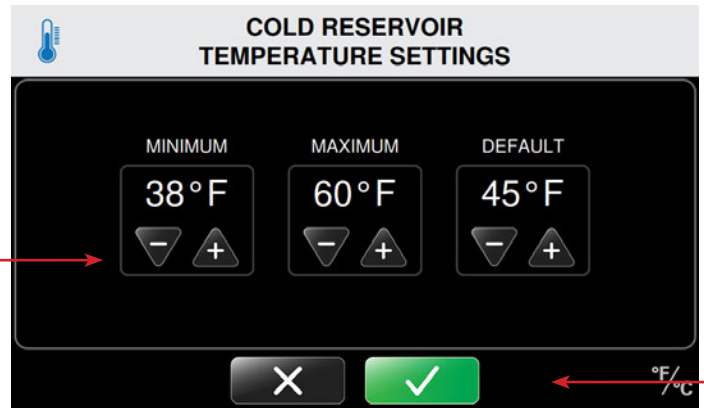

2. Press the plus (+) arrows to increase or minus arrows (-) to decrease the minimum, maximum and default cold temperatures for therapy treatments.

When Cold Therapy mode is selected for a therapy, the Control Unit will default to the temperature set.

3. To confirm the default cold reservoir settings, press the Confirm button .
4. To cancel these settings, press the Cancel button.

Upon confirmation, the System Settings screen returns, allowing you to change other system settings.

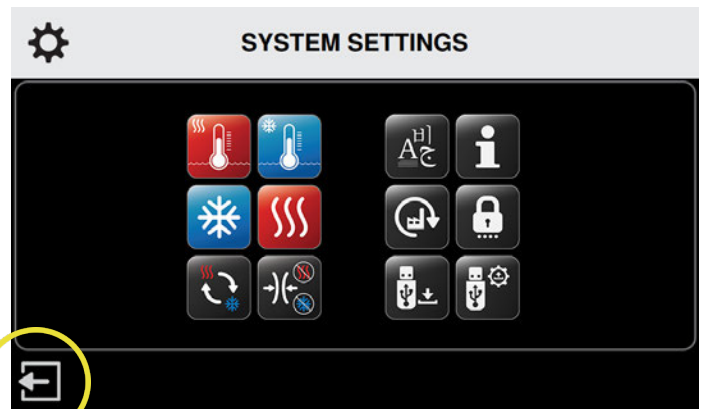

5. When you have made all desired changes, press the Exit icon to save the system settings.

The Control Unit's computer powers down.

6. Press the On/Off button located at the top of the touch screen to restart the computer.

COLD TIME SETTINGS

To set up the default time and compression settings for Cold Therapy:

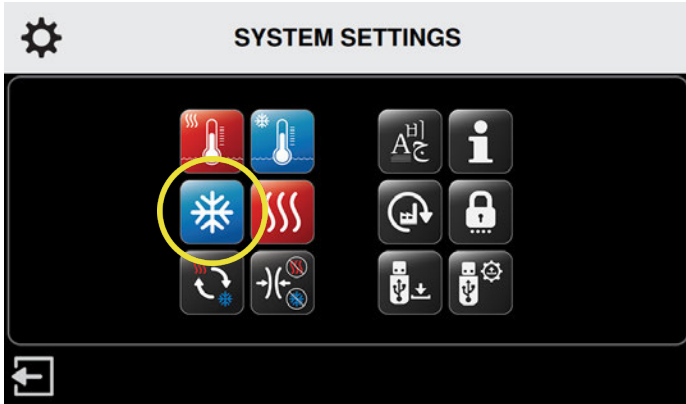

1. From the System Settings screen, press the Cold Settings icon

The Cold Therapy Settings screen appears.

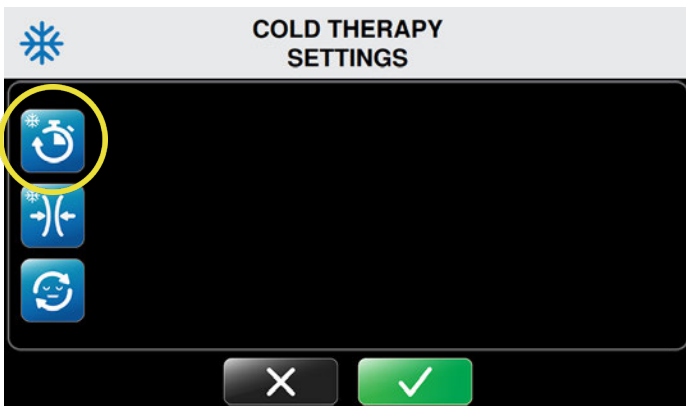

2. Press the Cold Time icon in the upper left hand corner of the screen.

The Cold Therapy Time Settings screen appears.



This screen allows you to control minimum, maximum and default cold session time settings. Times are set in five minute increments displayed in minutes: seconds.

NOTE: The Control Unit has factory time settings set at minimum 5 minutes and maximum 60 minutes. The default time setting is set at 15 minutes.





3. Press the plus (+) arrows to increase or minus arrows (-) to decrease the minimum, maximum and default cold times for therapy treatments.

When Cold Therapy mode is selected for a therapy, the Control Unit will default to the time set.

4. To confirm default cold time settings, press the  Confirm button.
5. To cancel these settings, press the  Cancel button.

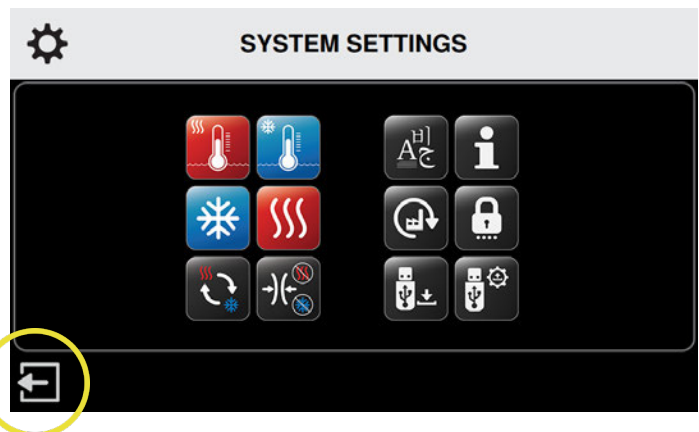
Upon confirmation, the System Settings screen returns, allowing you to change other system settings.



6. When you have made all desired changes, press the  Exit icon to save the system settings.

The Control Unit's computer powers down.

7. Press the On/Off button located at the top of the touch screen to restart the computer.

COLD COMPRESSION SETTINGS

To set up the default compression settings for Cold Therapy:

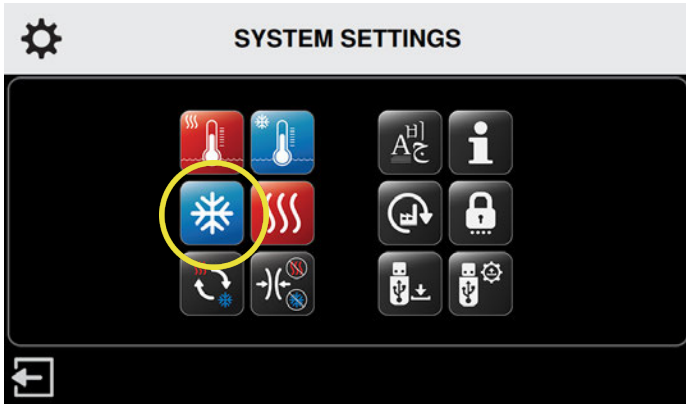

1. From the System Settings screen, press the Cold Settings icon.

The Cold Therapy Settings screen appears.



2. Press the Cold Compression icon on the left hand side of the screen.

The Cold Therapy Compression Settings screen appears.

This screen allows you to control the maximum cold compression setting. The minimum and default settings are set to No compression and cannot be changed. This ensures that No compression is always an option for individual sessions.

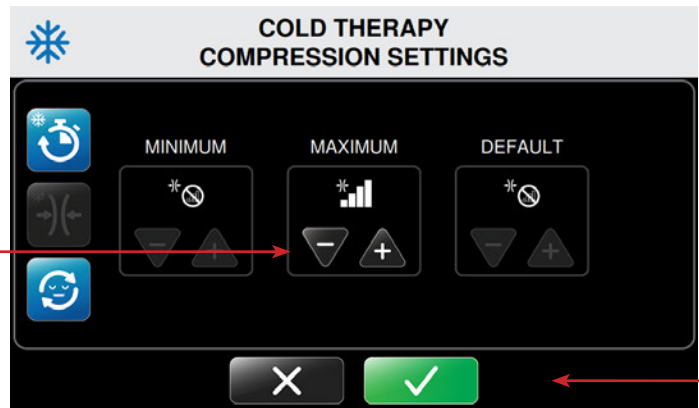

3. Press the plus (+) arrows to increase or the minus (-) arrows to decrease the maximum and default cold compression settings.

Available compression levels:

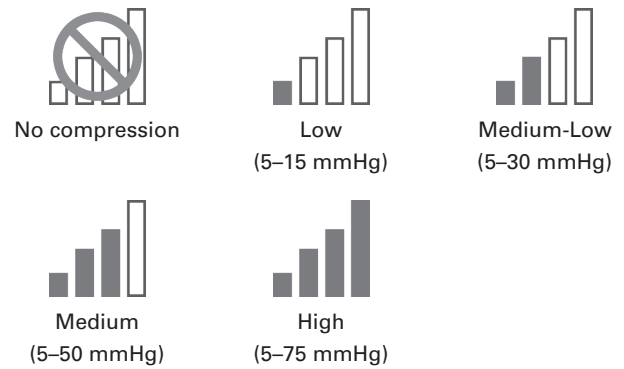

4. To confirm default cold compression settings, press the Confirm button.
5. To cancel these settings, press the Cancel button.

Upon confirmation, the System Settings screen returns, allowing you to change other system settings.

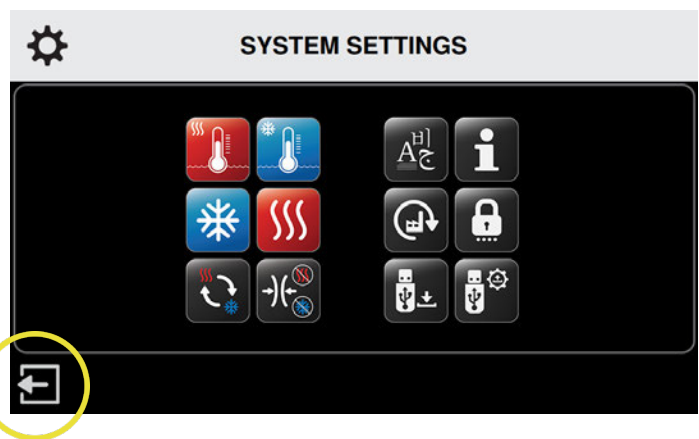

6. When you have made all desired changes, press the Exit icon to save the system settings.

The Control Unit's computer powers down.

7. Press the On/Off button located at the top of the touch screen to restart the computer.

SNOOZE FUNCTION

The Snooze function is available for Cold Therapy treatments only. This function allows you to set up to six snooze cycles. One cycle consists of Cold Therapy on and Cold Therapy off (Snooze). The length of time for both Cold Therapy on and Cold Therapy off (Snooze) can be set by the user.

To set up the default Snooze settings for Cold Therapy:

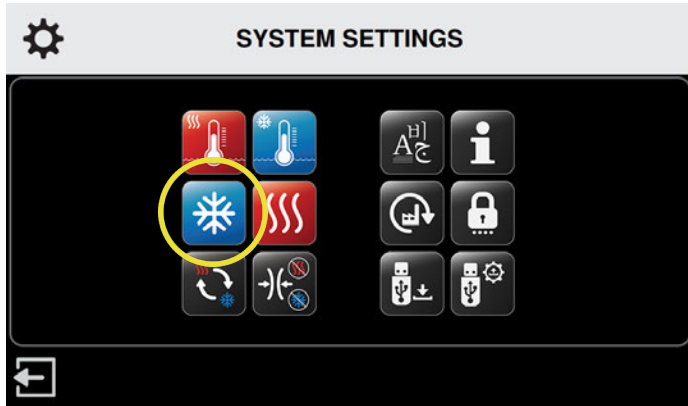

1. From the System Settings screen, press the Cold Settings icon.

The Cold Therapy Settings screen appears.

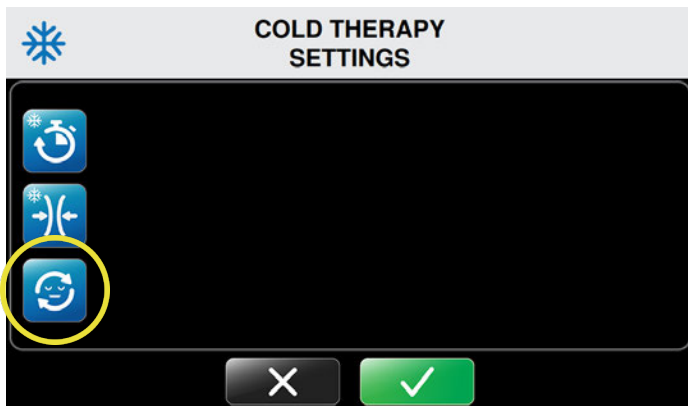

2. Press the Snooze Settings icon on the left hand side of the screen.

The Cold Therapy Snooze Settings screen appears.

NOTE: The Snooze function is disabled by default. Pressing the green snooze icon enables snooze. When snooze is enabled, pressing the red snooze icon will disable snooze.



Cold Therapy
Snooze Disabled



Cold Therapy
Snooze Enabled



Press the green Snooze icon to enable the Snooze function.



Press the red Snooze icon to disable the Snooze function.



3. To enable Snooze, press the  Enable Snooze icon.

The Cold Therapy Snooze Settings screen refreshes.

This screen allows you to control the minimum, maximum and default amount of time the Control Unit sleeps (pauses) between therapy cycles. Times are set in five-minute increments displayed in minutes: seconds.



4. Press the plus (+) arrows to increase or minus arrows (-) to decrease the minimum, maximum and default Snooze times for therapy treatments.

NOTE: To disable Snooze, press the  Disable Snooze icon.

5. To confirm default Snooze settings, press the  Confirm button.

6. To cancel these settings, press the  Cancel button.

Upon confirmation, the System Settings screen returns, allowing you to change other settings.

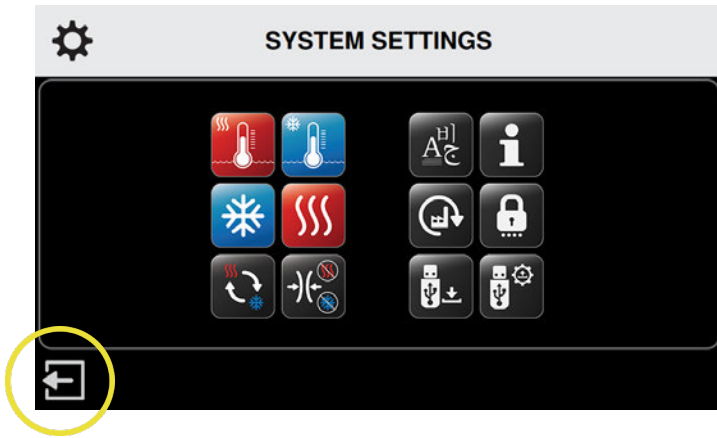

7. When you have made all desired changes, press the  Exit icon to save the system settings.

The Control Unit's computer powers down.

8. Press the On/Off button located at the top of the touch screen to restart the computer.

RAPID CONTRAST SETTINGS

The Med4 Elite enables you to define the following Rapid Contrast default settings:

For the Cold Therapy portions of Rapid Contrast Therapy:

- Minimum, maximum and default session times
- Compression settings: Low, Medium-low, Medium, High and No compression

For the Heat Therapy portions of Rapid Contrast Therapy:

- Minimum, maximum and default session times
- Compression settings: Low and No compression

For Rapid Contrast Therapy sessions in general:

- Minimum, maximum and default total session times

These settings determine the limits the Med4 Elite can be set for individual therapy sessions.

COLD TIME SETTINGS IN RAPID CONTRAST THERAPY

To set up the default times for the Cold Therapy portions of Rapid Contrast therapy:

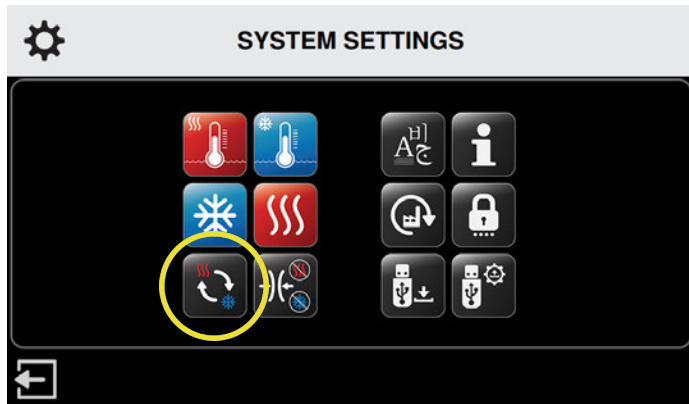

1. From the System Settings screen, press the Rapid Contrast icon.

The Rapid Contrast Therapy Settings screen appears.

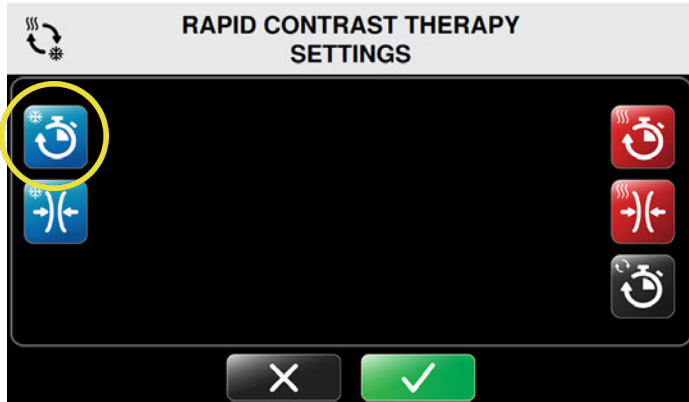

2. To set the cold contrast time defaults, press the Cold Contrast Time icon.

The Rapid Contrast Therapy Cold Time Settings screen appears

This screen allows you to control minimum, maximum and default session time settings. Times are set in one minute increments displayed in minutes: seconds.



3. Press the plus (+) arrow to increase or the minus (-) arrow to decrease the minimum, maximum and default cold times.

This will be the default cold session time for Rapid Contrast Therapy when the Control Unit is turned on and Rapid Contrast Therapy mode is selected.

4. To confirm default cold time settings for Rapid Contrast Therapy, press the Confirm button.
5. To cancel these settings, press the Cancel button.

Upon confirmation, the System Settings screen returns, allowing you to change other settings.

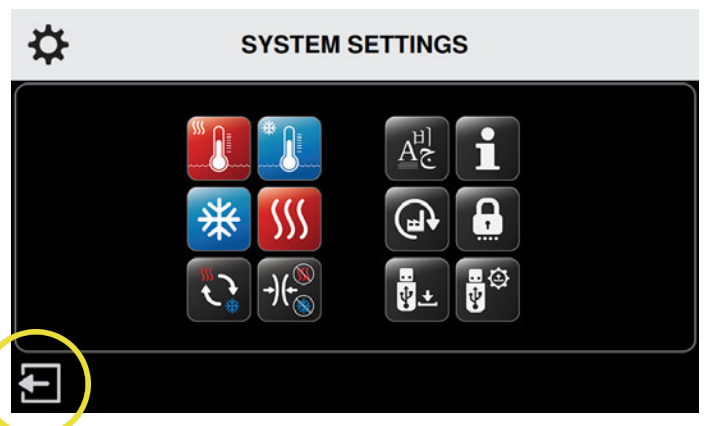

6. When you have made all desired changes, press the Exit icon to save the system settings.

The Control Unit's computer powers down.

7. Press the On/Off button located at the top of the touch screen to restart the computer.

COLD COMPRESSION SETTINGS IN RAPID CONTRAST THERAPY

To set up the default compression settings for the Cold Therapy portions of Rapid Contrast therapy:

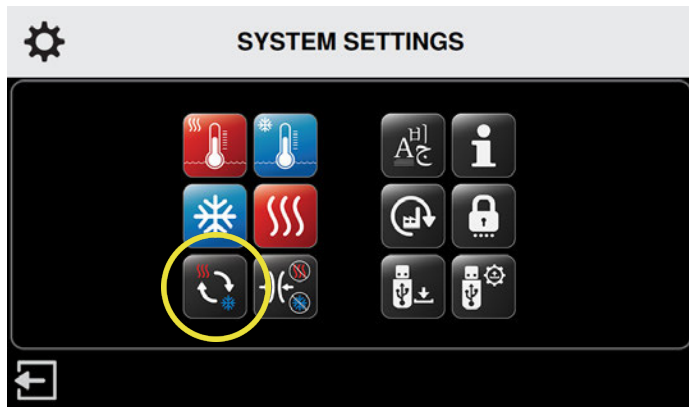

1. From the System Settings screen, press the Rapid Contrast icon

The Rapid Contrast Therapy Settings screen appears.

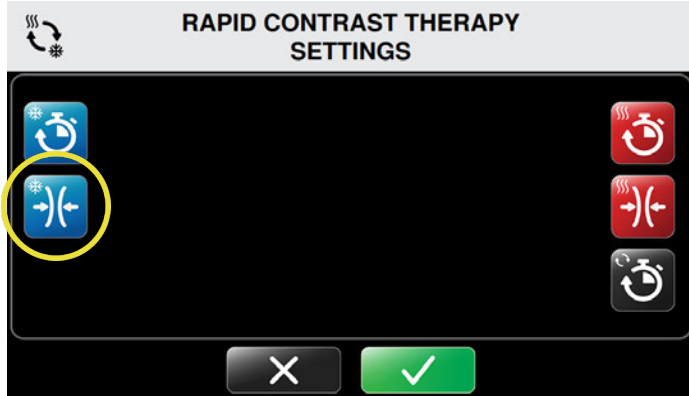

2. To set up the Cold Compression default, press the Cold Compression Contrast icon.

The Rapid Contrast Therapy Cold Compression Settings screen appears.

This screen allows you to control the maximum contrast compression setting. The minimum and default settings are set to No compression and cannot be changed. This ensures that No compression is always an option for individual sessions.

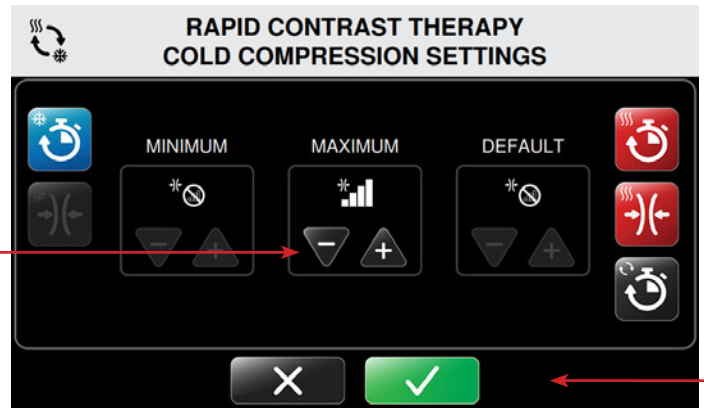

3. Press the plus (+) arrow to increase or the minus (-) arrow to decrease the maximum and default compression settings.

Available compression levels:

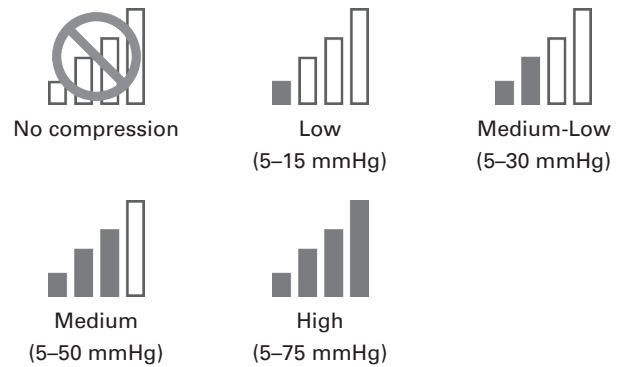

4. To confirm default cold compression settings in Rapid Contrast Therapy, press the Confirm button.
5. To cancel these settings, press the Cancel button.

Upon confirmation, the System Settings screen returns, allowing you to change other settings.

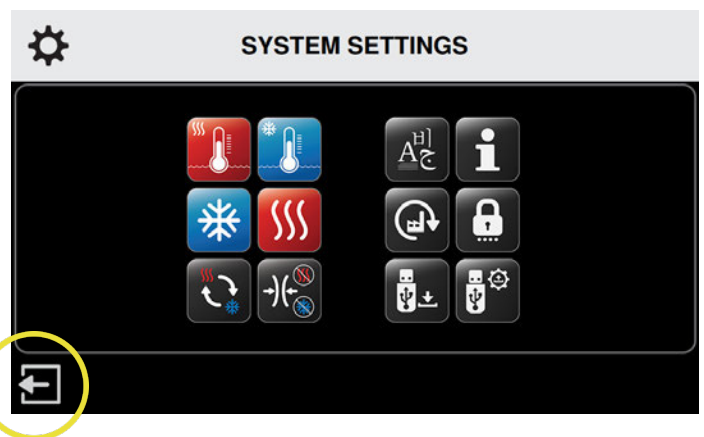

6. When you have made all desired changes, press the Exit icon to save the system settings.

The Control Unit's computer powers down.

7. Press the On/Off button located at the top of the touch screen to restart the computer.

HEAT TIME SETTINGS IN RAPID CONTRAST THERAPY

To set up the default times for the Heat Therapy portions of Rapid Contrast therapy:

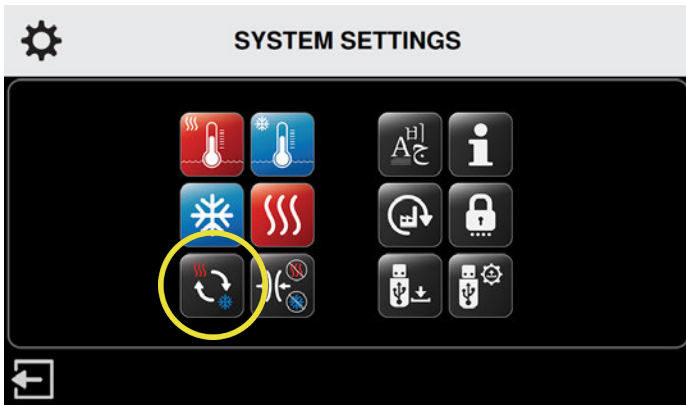

1. From the System Settings screen, press the Rapid Contrast icon.

The Rapid Contrast Therapy Settings screen appears.



2. To set the heat contrast time defaults, press the Heat Contrast Time icon.

The Rapid Contrast Therapy Heat Time Settings screen appears.

This screen allows you to control minimum, maximum and default session time settings. Times are set in one minute increments displayed in minutes: seconds.

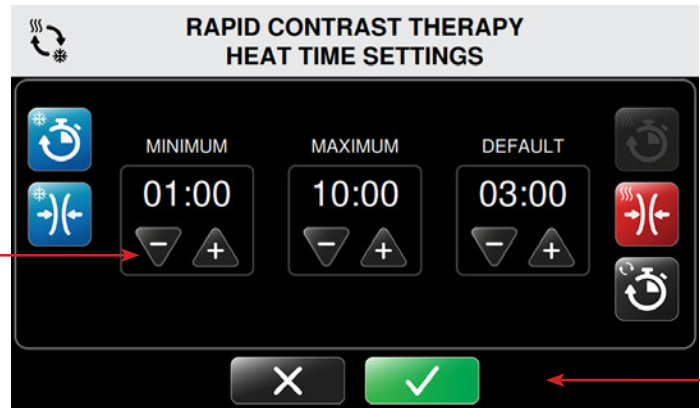

3. Press the plus (+) arrows to increase or minus arrows (-) to decrease the minimum, maximum and default heat times

This will be the default heat session time in Rapid Contrast Therapy when the Control Unit is turned on and Rapid Contrast Therapy mode is selected.

4. To confirm default heat time settings for Rapid Contrast Therapy, press the Confirm button.
5. To cancel these settings, press the Cancel button.

Upon confirmation, the System Settings screen returns, allowing you to change other settings.

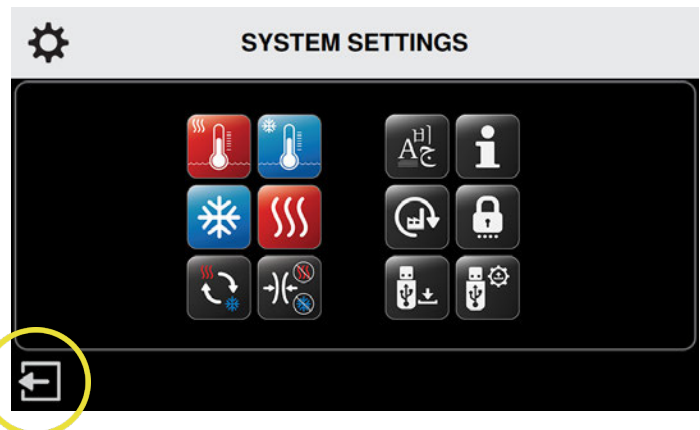

6. When you have made all desired changes, press the Exit icon to save the system settings.

The Control Unit's computer powers down.

7. Press the On/Off button located at the top of the touch screen to restart the computer.

HEAT COMPRESSION SETTINGS IN RAPID CONTRAST THERAPY

To set up the default compression settings for the Heat Therapy portions of Rapid Contrast therapy:

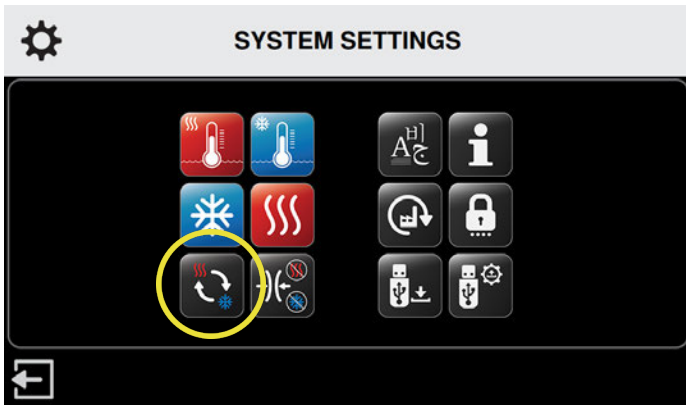

1. From the System Settings screen, press the Rapid Contrast icon.

The Rapid Contrast Therapy Settings screen appears.

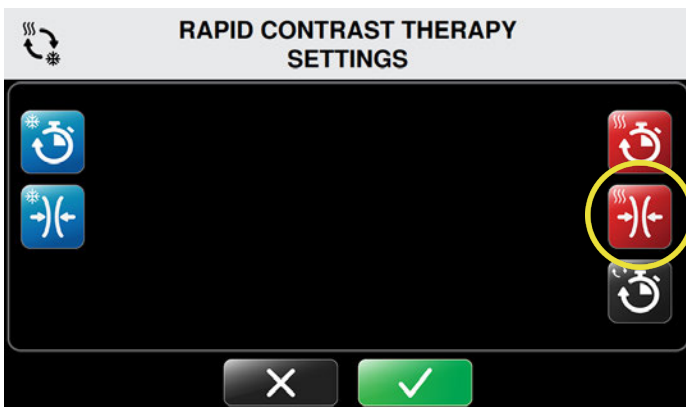

2. To set up the Heat Compression default, press the Heat Compression Contrast icon.

The Rapid Contrast Therapy Heat Compression Settings screen appears.

This screen allows you to control the maximum contrast compression setting. The minimum and default settings are set to No compression and cannot be changed. This ensures that No compression is always an option for individual sessions.

NOTE: The Med4 Elite has a maximum setting of Low compression, as indicated for use with Heat Therapy. This setting cannot be exceeded.

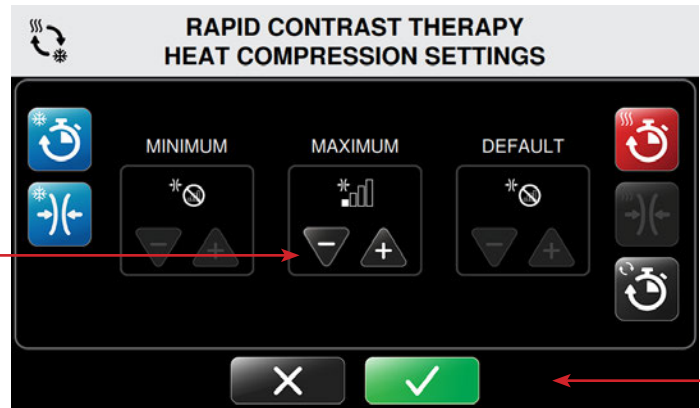

3. Under the maximum setting, press the minus (-) arrow to disabled or plus arrow (+) to set to Low compression for Rapid Contrast therapy treatments.

Available compression levels:

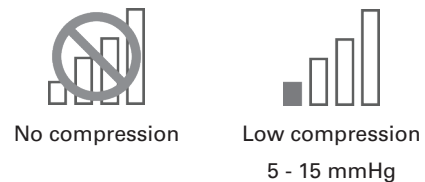

4. To confirm default heat compression settings, press the Confirm button.
5. To cancel these settings, press the Cancel button.

Upon confirmation, the System Settings screen returns, allowing you to change other settings.

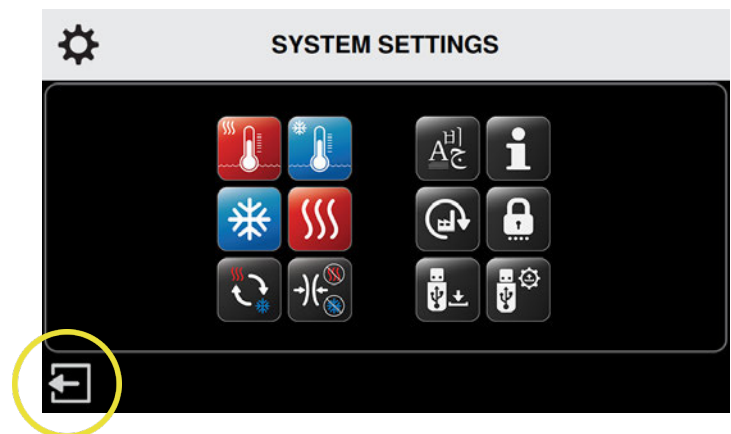

6. When you have made all desired changes, press the Exit icon to save the system settings.

The Control Unit's computer powers down.

7. Press the On/Off button located at the top of the touch screen to restart the computer.

TOTAL TIME SETTINGS IN RAPID CONTRAST THERAPY

The Total Time setting for Rapid Contrast Therapy defines the duration of an entire Rapid Contrast Therapy session. When Total Time is set, the Cold and Heat Therapies will repeat one after the other within that total time.

To set up the default total times for Rapid Contrast therapy:

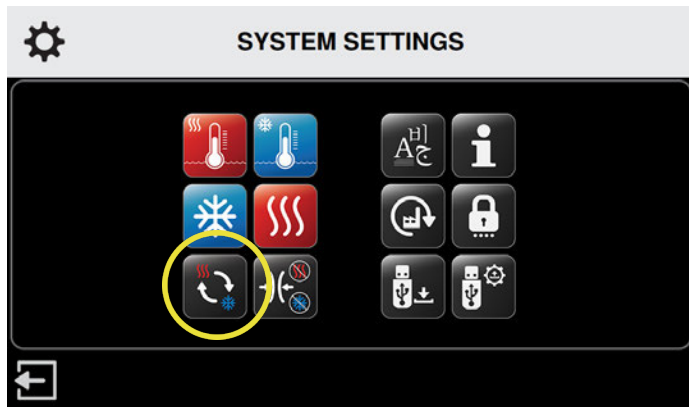

1. From the System Settings screen, press the Rapid Contrast icon.

The Rapid Contrast Therapy Settings screen appears.



2. To set up the Total Time default, press the Total Time icon.

The Rapid Contrast Therapy Total Time Settings screen appears.

This screen allows you to control minimum, maximum and default session time settings. Total times are set in five minute increments displayed in minutes: seconds.

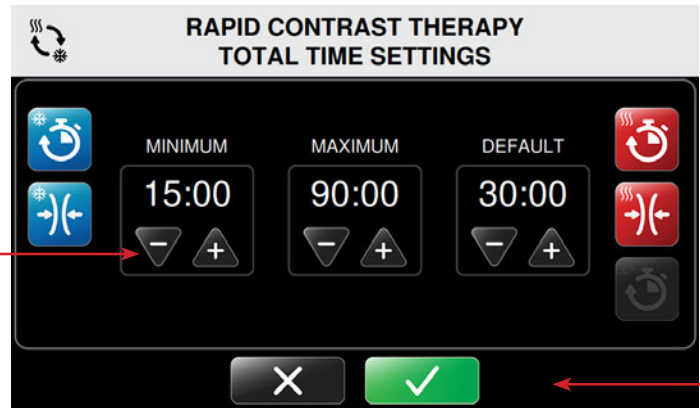

3. Press the plus (+) arrows to increase or minus arrows (-) to decrease the minimum, maximum and default time for therapy treatments.

This will be the default total time in Rapid Contrast Therapy when the Control Unit is turned on and Rapid Contrast Therapy mode is selected.

4. To confirm default total rapid contrast session time settings, press the Confirm button .
5. To cancel these settings, press the Cancel button.

Upon confirmation, the System Settings screen returns, allowing you to change other settings.

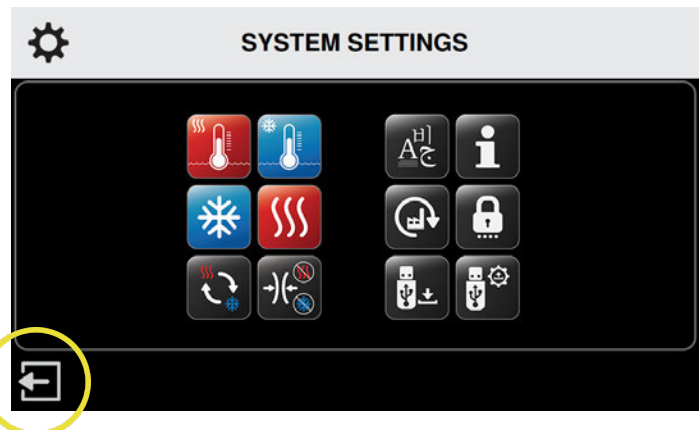

6. When you have made all desired changes, press the Exit icon to save the system settings.

The Control Unit's computer powers down.

7. Press the On/Off button located at the top of the touch screen to restart the computer.

COMPRESSION-ONLY SETTINGS

The Med4 Elite enables you to define the following Compression-Only default settings:

- Minimum, maximum and default therapy session times
- Compression settings: Low, Medium-low, Medium and High

These settings determine the limits the Med4 Elite can be set for individual therapy sessions.

COMPRESSION TIME SETTINGS

To set up the default times for Compression-Only therapy:

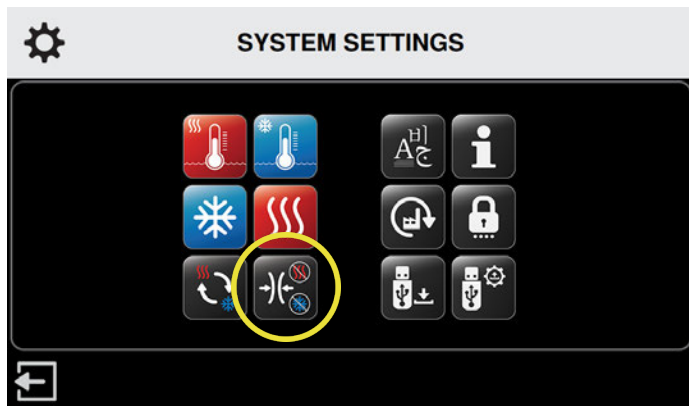

1. From the System Settings screen, press the Compression Settings icon.

The Compression-Only Therapy Settings screen appears.

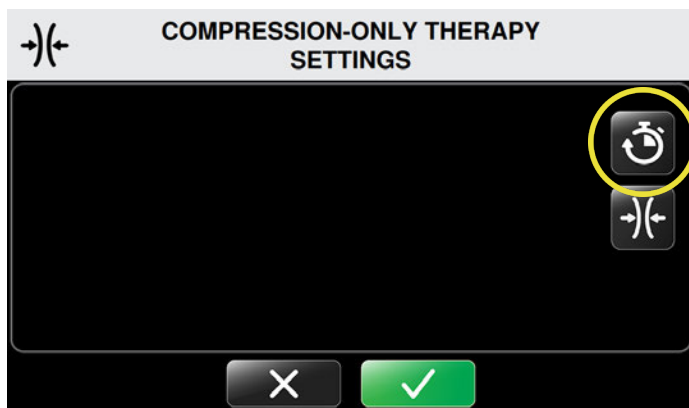

2. Press the Compression-Only Time Setting icon.

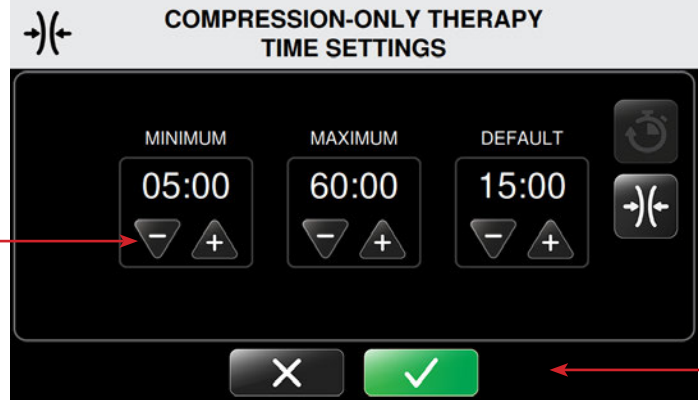

The Compression-Only Therapy Time Settings screen appears.

This screen allows you to control minimum and maximum time settings and the default session time settings. Time is set in five minute increments with times displayed in minutes: seconds.





3. Press the plus (+) arrows to increase or minus arrows (-) to decrease the minimum, maximum and default times for therapy treatments.

This will be the default time settings time when the Control Unit is turned on and Compression-Only Therapy mode is selected.

4. To confirm default compression time settings, press the  Confirm button.
5. To cancel these settings, press the  Cancel button.

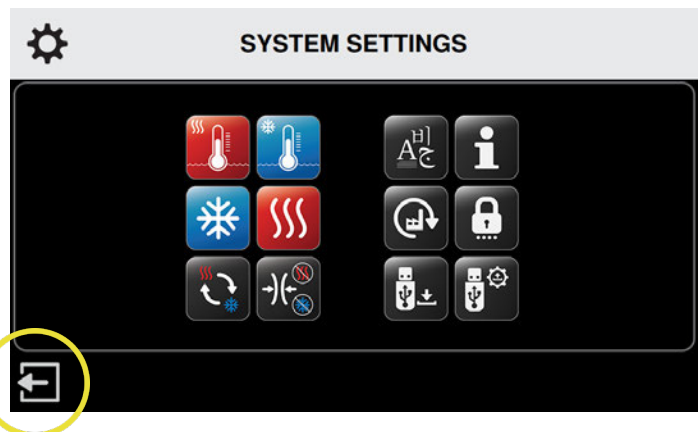
Upon confirmation, the System Settings screen returns, allowing you to change other settings.



6. When you have made all desired changes, press the  Exit icon to save the system settings.

The Control Unit's computer powers down.

7. Press the On/Off button located at the top of the touch screen to restart the computer.

COMPRESSION SETTINGS IN COMPRESSION-ONLY THERAPY

To set up the default compression settings for Compression-Only Therapy:

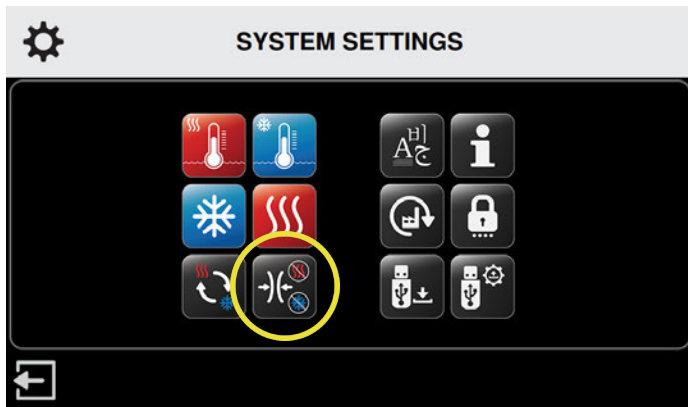

1. From the System Settings screen, press the Compression Settings icon.

The Compression-Only Therapy Settings screen appears.

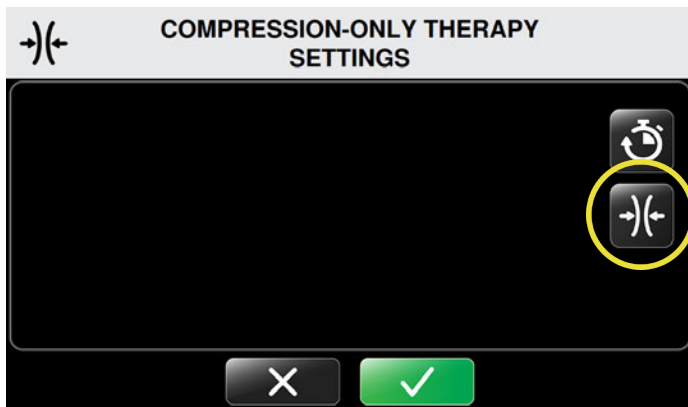

2. To set the Compression Settings, press the Compression Icon in the Compression Settings screen.

The Compression-Only Therapy Compression Settings screen appears.

This screen allows you to control the compression level settings. The default Minimum setting for Compression-Only Therapy is Low Compression. The No compression option is not available. The compression options available are Low, Medium-low, Medium and High compression.



3. Press the plus (+) arrows to increase or minus arrows (-) to decrease the maximum and default compression level settings for therapy treatments.

Available compression levels:

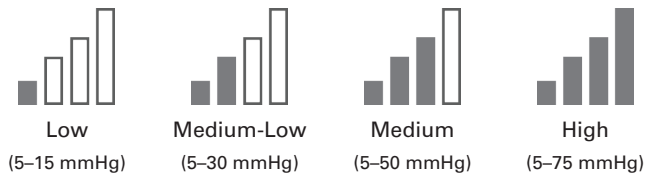

These will be the default compression level settings when the Control Unit is turned on and Compression-Only Therapy mode is selected.

4. To confirm default compression settings, press the Confirm button.
5. To cancel these settings, press the Cancel button.

Upon confirmation, the System Settings screen returns, allowing you to change other settings.

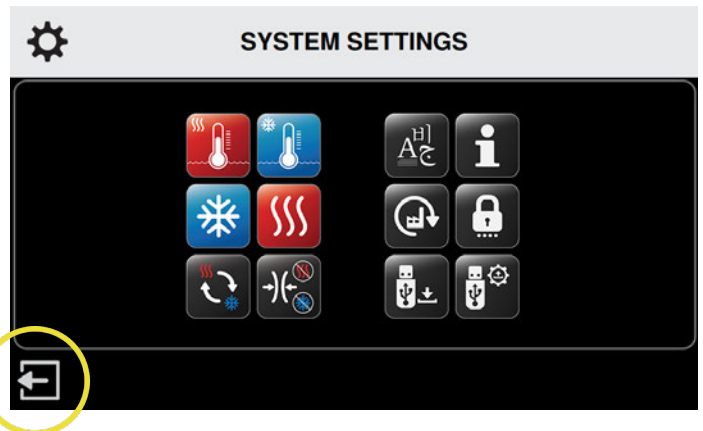

6. When you have made all desired changes, press the Exit icon to save the system settings.

The Control Unit's computer powers down.

7. Press the On/Off button located at the top of the touch screen to restart the computer.

RESETTING THE MED4 ELITE TO FACTORY SETTINGS

You may reset the Med4 Elite control unit back to factory defaults. The PIN will not reset.

To reset all settings to factory settings:

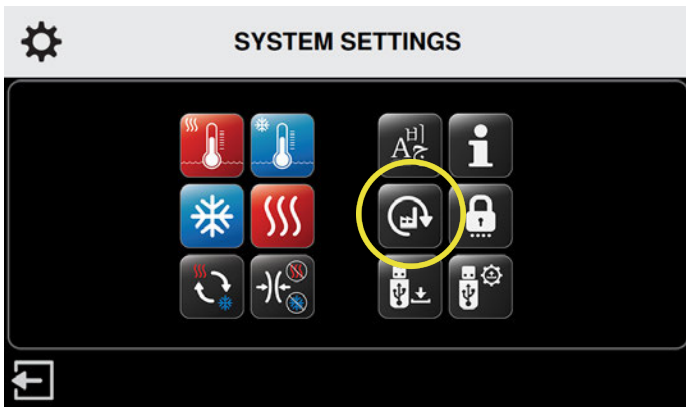

1. From the System Settings screen, press the Apply Factory Reset Icon.

The Enter PIN screen appears.

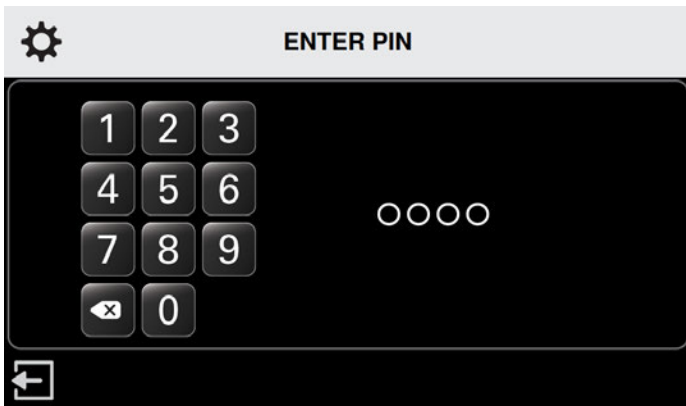



NOTE: Press the  Exit icon to return to the System Settings screen without Applying Factory Reset.

2. To reset settings, press the appropriate numbers to enter the PIN.

The Apply Factory Reset screen appears.



3. To apply Factory Reset, press the  Confirm button.
4. To cancel these settings, press the  Cancel button.

The Confirm Factory Reset screen appears.



5. To confirm Factory Reset, press the  Confirm button.

Upon confirmation, the Restart to Apply Settings screen appears.

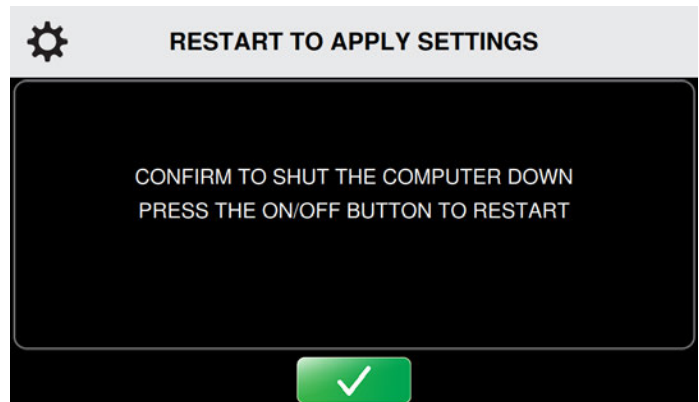

6. Press the  Confirm button to restart the Control Unit.

The Control Unit's computer powers down.

7. Press the On/Off button located at the top of the touch screen to restart the computer.

CHANGING THE LANGUAGE

The Med4 Elite enables you to view the user interface in one of 19 different languages. Use the System Settings to choose your desired language:

Arabic	French	Polish
Chinese (Simplified)	German	Portuguese (Brasil)
Danish	Greek	Russian
Dutch	Hebrew	Spanish (Latin America)
English	Italian	Swedish
Finnish	Japanese	Turkish
	Korean	

To set the User Interface language on the Control Unit:

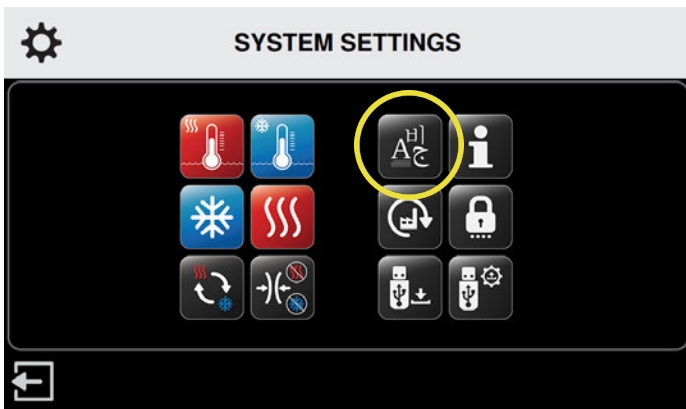

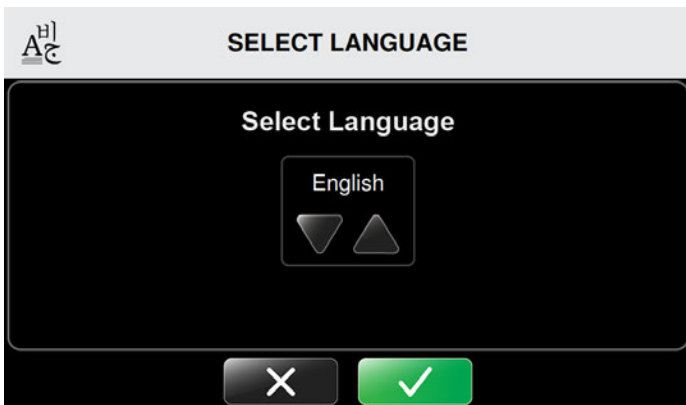

1. From the System Settings screen, press the Language Icon on the settings screen.

The Select Language screen appears.



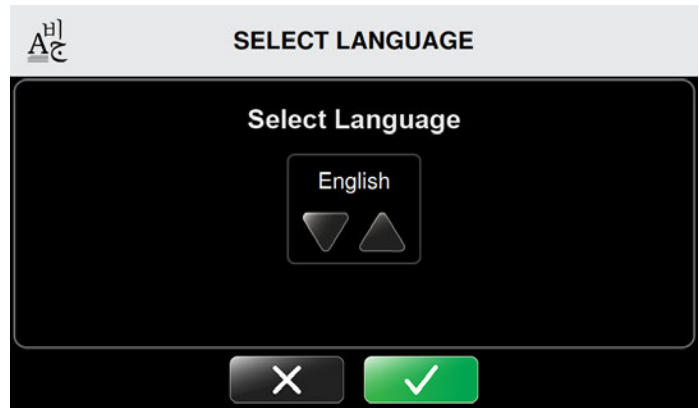

2. Press the up or down arrows to scroll through the available languages.





3. To select the default language setting, press the  Confirm button.
4. To cancel these settings, press the  Cancel button.

The Confirm Language screen appears.

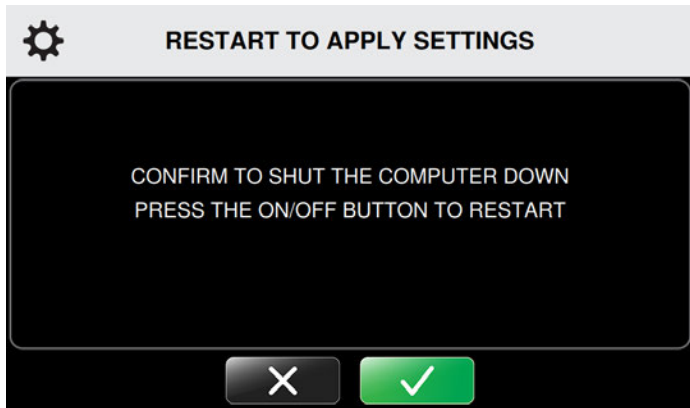

5. To confirm the default language setting, press the  Confirm button.
6. To cancel these settings, press the  Cancel button.



- Restart to Apply Settings by pressing the  Confirm button a second time.

The Control Unit's computer powers down.

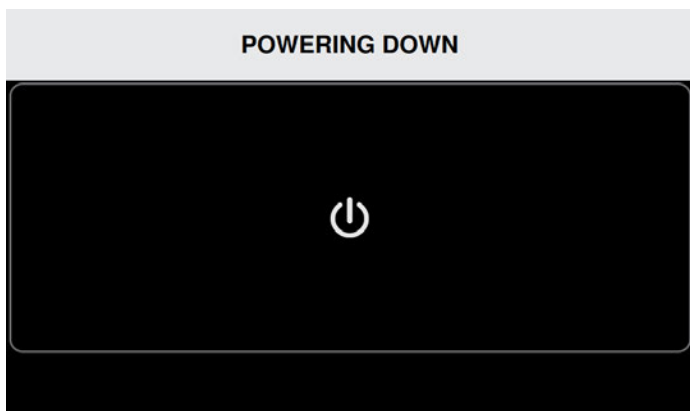

- Press the On/Off button located at the top of the touch screen to restart the computer.

WORKING WITH MED4 ELITE SYSTEM SOFTWARE AND INFORMATION

VIEWING SYSTEM INFORMATION

The Med4 Elite enables the quick viewing of important Control Unit information, which can help with support and troubleshooting.

To view Control Unit information:

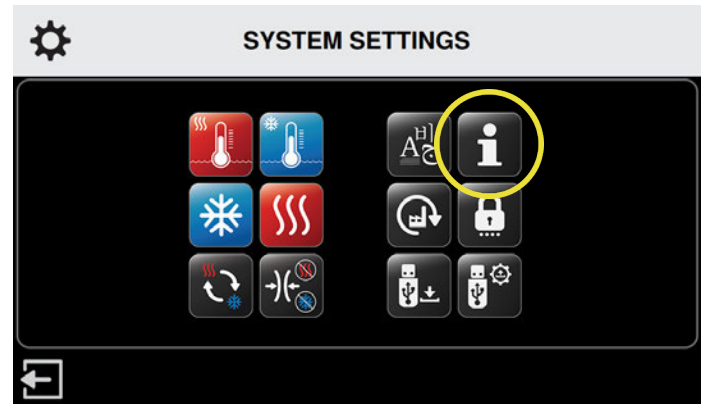

- From the System Settings screen, press the System Info icon.

The System Information screen appears.



The screen displays the GUI Operating System (OS), GUI Application (App) Version, and Real Time Control Board (RTCB) Version of the Control Unit.

- To exit System Info, press the  Return button to return to the System Settings screen.

DOWNLOADING DATA

Download usage data from the Med4 Elite onto the Game Ready USB flash drive that was provided with your Control Unit. If you are unable to locate your Game Ready USB flash drive, or you have completed downloading, contact Game Ready Customer Service to provide this data for troubleshooting and diagnostics. In the U.S. contact Game Ready Technical Support at 1.888.GameReady (1.888.426.3732) or 1.510.868.2100. From outside the U.S., contact your local distributor.

To download data from the Control Unit:

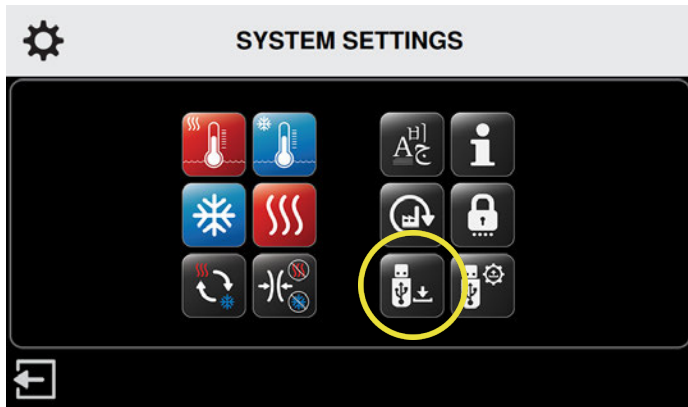

1. From the System Settings screen, press the Data Download icon.

The Data Download screen appears. To cancel this function and return to the System Settings main menu, press the  Cancel button.

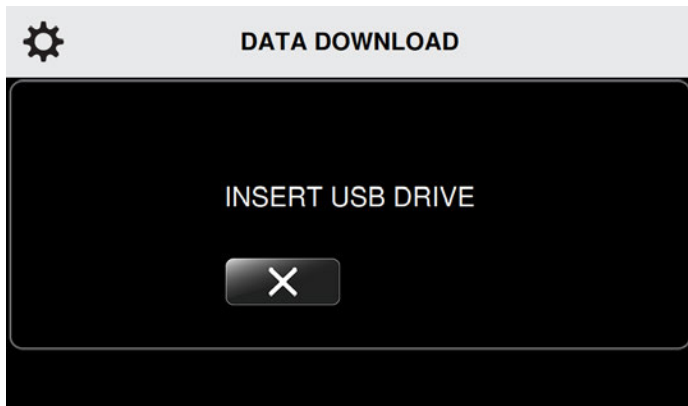

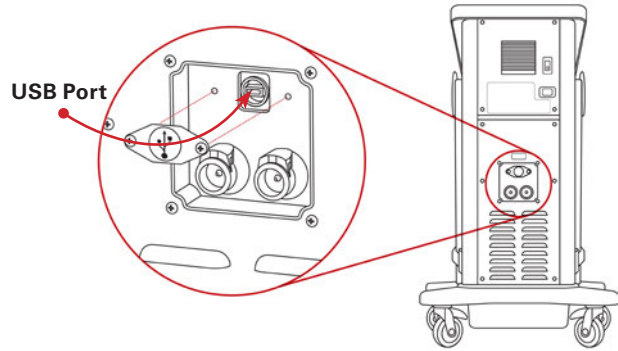

2. Using a Phillips screw driver, remove the USB port cover at back of Control Unit.

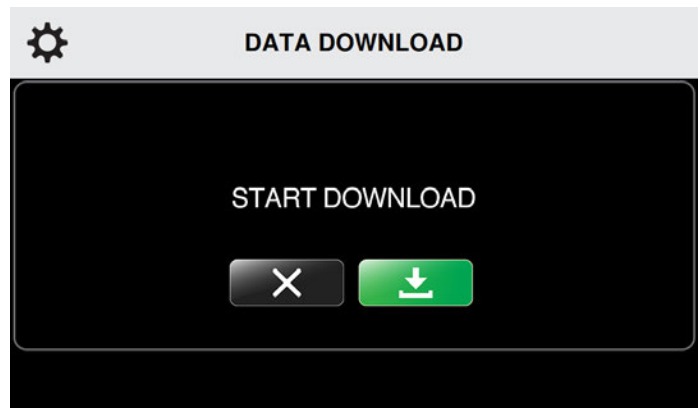

3. Insert the Game Ready provided USB flash drive into the USB port on the Control Unit. The Data Download screen refreshes.

NOTE: Only Game Ready USB flash drives will work with the Med4 Elite. Do not use other USB drives.



4. To start the data download, press the  Start button .
5. To cancel this function, press the  Cancel button.

The Data Download screen refreshes.

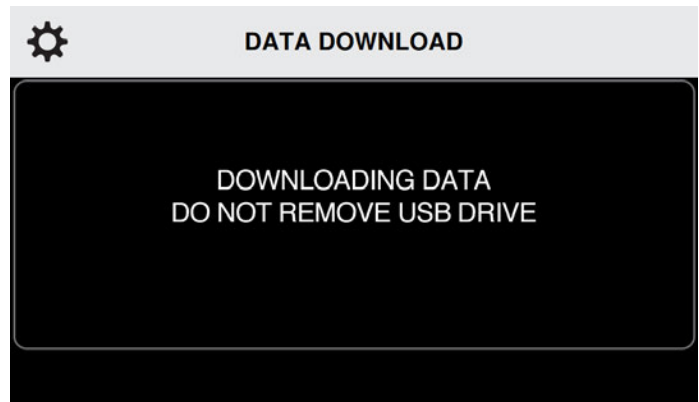

If data download is successful, the Download Successful screen appears.

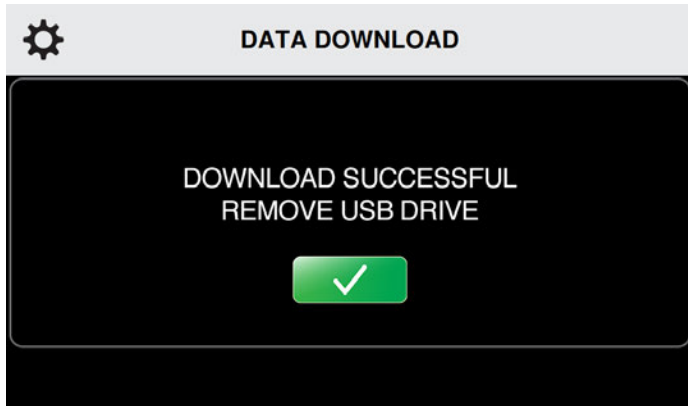

- Remove the USB flash drive from the Control Unit's USB port to return to the System Settings main menu. Replace the USB port cover on back of Control Unit.

If there is a problem during the download, the screen displays the message, Download Failed.

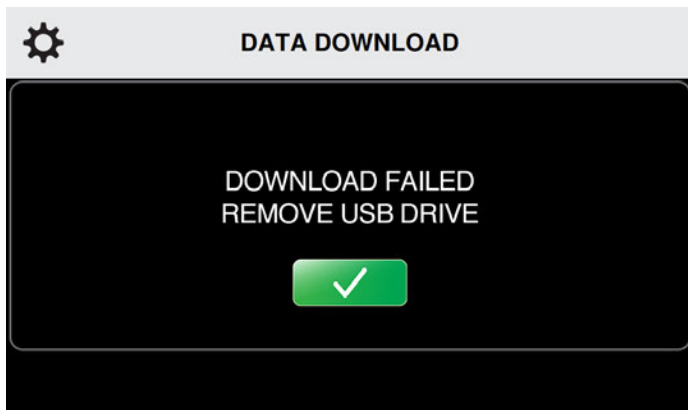

- Remove the USB flash drive from the Control Unit's USB port. Return to Step 3 to try the download again.

NOTE: Replace the cover on the USB port to prevent unapproved use.

NOTE: The USB port is designed for Data Downloads and Software Updates only. Use USB drives loaded only with software for the Med4 Elite.

UPDATING THE SYSTEM SOFTWARE

To install software updates:

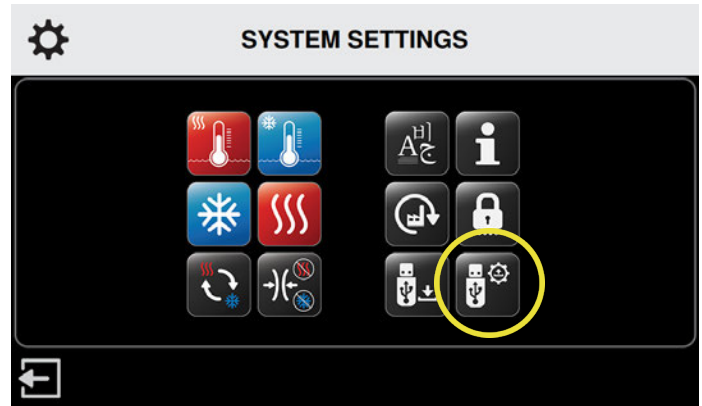

- From the System Settings screen, press the Software Update icon.

The Software Update screen appears. To cancel this function and return to the System Settings main menu, press the **X** Cancel button.

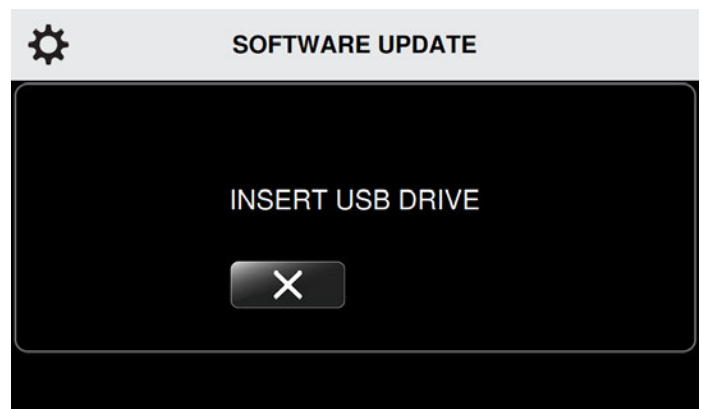

- Using a Phillips screw driver, remove the USB port cover at back of Control Unit

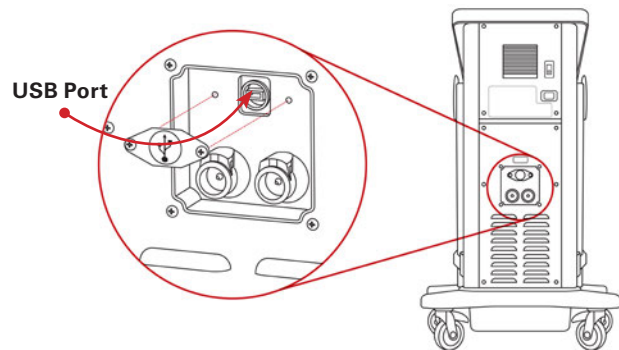

- Insert the Game Ready provided USB flash drive into the USB port. The Software Update screen refreshes, displaying the version of software installed on the Control Unit.

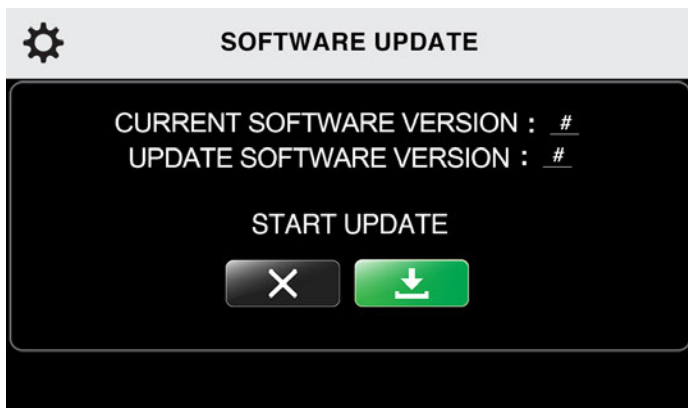

NOTE: To learn whether you have the most current version, go to www.gameready.com. If you don't have the most recent version, call Game Ready Customer Service. If your operating system needs to be updated, Game Ready will send you a USB flash drive with the software preloaded.

4. If an update is not necessary, press the Cancel button.
5. If an update is necessary, press the Start button to start the update.

The Med4 Elite installs the new software. The Software Update screen refreshes.



When the update is complete, the Control Unit indicates the Software Update was successful.

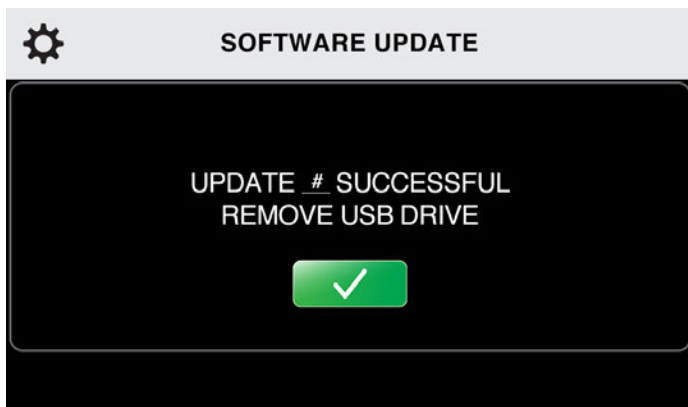

6. Remove the USB flash drive.
7. Replace USB port cover on back of Control Unit.

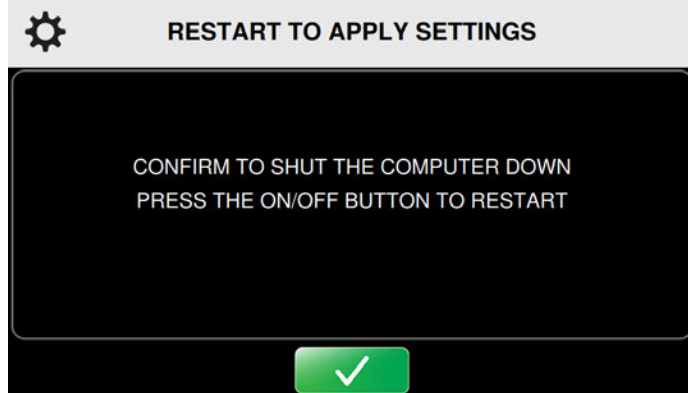

8. Press the Confirm Button to apply the update. The Control Unit's computer powers down.
9. Press the On/Off button located at the top of the touch screen to restart the computer.

NOTE: Replace the cover on the USB port to prevent unapproved use.

NOTE: The USB port is designed for Data Downloads and Software Updates only. Use USB drives loaded only with software for the Med4 Elite.

If there is a problem during the update, the Control Unit indicates the Software Update failed.

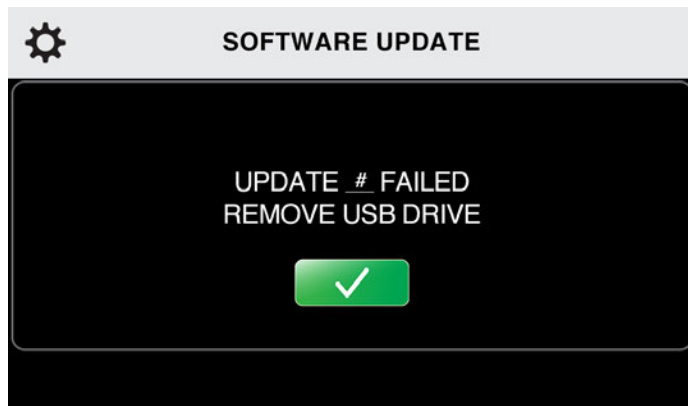

10. Remove the USB drive from the Control Unit. The Software Update screen appears. Insert USB flash drive again to retry.

If the Software Update fails after several attempts, contact Technical Support. In the U.S. contact Game Ready Technical Support at 1.888. GameReady (1.888.426.3732) or 1.510.868.2100. From outside the U.S., contact your local distributor.

STORING, CLEANING AND MAINTAINING THE MED4 ELITE

STORING

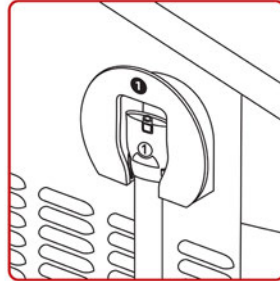
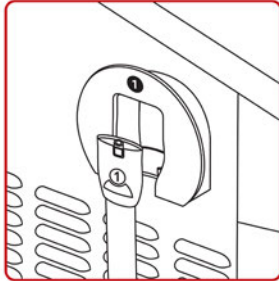
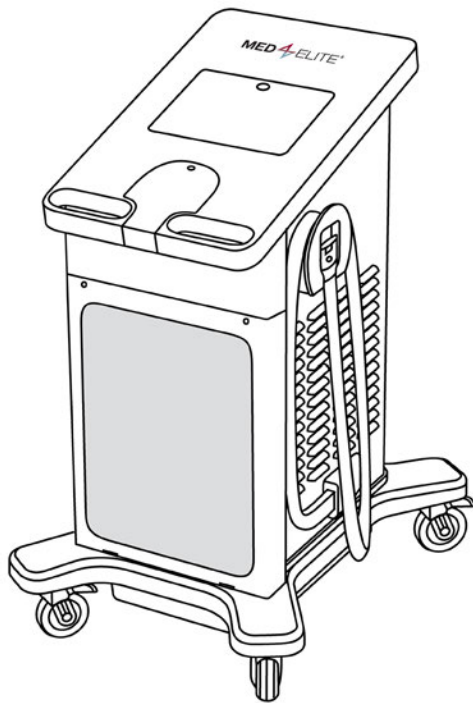

To store the Control Unit at the end of a therapy session:

1. Wrap the Hose once around the Hose hanger and place the end into the holster as shown above. Ensure the numbered Hose Connector corresponds with the number on the Hose hanger.
2. Press and hold the On/Off button located at the top of the touch screen for three seconds to power down the computer.

To store the Control Unit at the end of each day:

1. Power off the Control Unit by moving the power switch on the back of the Control Unit to the off position.
2. Unplug the Control Unit power cord from the wall outlet.
3. Wrap the Hose once around the Hose hanger and place the end into the holster as shown above. Ensure the numbered Hose Connector corresponds with the number on the Hose hanger.

4. If moving, unplug the power cord from the back of the Control Unit.
5. Unlock the wheel casters, and using the handles, move the Control Unit to its storage location.
6. Once the Control Unit is located in the appropriate location, make sure to lock the four casters in place.

To store the Control Unit if it will not be in use for more than two weeks:

1. Power off the Control Unit by moving the power switch on the back of the Control Unit to the off position.
2. Unplug the Control Unit from the outlet.
3. Unplug the power cord from the back of the Control Unit.
4. Wrap the Hose once around the Hose hanger and place the end into the holster as shown below. Ensure the numbered Hose Connector corresponds with the number on the Hose hanger.
5. Drain the reservoirs as described in *Cleaning and Maintaining > Control Unit Reservoirs*.
6. Unlock the wheel casters, and using the handles, move the Control Unit to its storage location.

IMPORTANT: The Med4 Elite should never be tipped on its side. Tipping of the control unit may cause damage to the compressor and may void the warranty.

7. Once Control Unit is located in the appropriate location, make sure to lock the four casters in place.
8. Clean and store Wraps as described in *Cleaning and Maintaining > Wraps*.

CLEANING AND MAINTAINING

The Expected Service Life of the Med4 Elite Control Unit is five (5) years.

Regular cleaning and maintenance will help to keep the Med4 Elite operating at peak performance.

CONTROL UNIT AND CONNECTOR HOSES (CLEAN AND MAINTAIN DAILY)

1. It is important to keep the Control Unit and Connector Hoses clean and as dust-free as possible. To ensure that your Med4 Elite remains in the best condition possible, we recommend that you clean the exterior surfaces, including the touch screen, and Connector Hoses with a soft cloth and one of the following:

- Mild detergent
- CaviCide™ or CaviWipes™
- Antifect® FF
- Mikrozyd® Sensitive Wipes
- Clorox Healthcare® Bleach Germicidal Wipes
- 70% isopropyl alcohol

NOTE: Do not apply liquid cleaner directly to the surface of the Control Unit. Always apply liquid cleaner to the cloth first.

Using some products to clean and maintain your Med4 Elite will void its warranty. Therefore, never use:

- Phenolic-based disinfectants (such as Amphy!®).
- Abrasive materials, which will damage the plastics.
- Any cleaning materials or solutions not specified in this User Manual.

CAUTION: The Med4 Elite is not waterproof. Do not apply a direct stream of any liquid onto the Control Unit, submerge the Control Unit or allow any liquid to pool onto the surface of the Control Unit.

2. Keep Hoses in place in their holsters on the Control Unit when not in use.
3. Keep Wraps clean by wiping off any spills or dirt immediately.

CONTROL UNIT RESERVOIRS (EVERY TWO WEEKS)

Drain and replace distilled water in reservoirs every two (2) weeks. To clean the Med4 Elite reservoirs, drain the reservoirs as described in the following section.

To drain the Med4 Elite reservoirs:

1. Turn off the Control Unit.
2. Using the drain hoses included with the Control Unit, put the end of each Hose without the connector into a container to catch water drainage. Once hoses are inserted, water will immediately drain from Control Unit. Make sure the container is set to capture water prior to Hose insertion.
3. Put the remaining end of each Hose with the connector into the reservoir drain outlets until you hear an audible click.

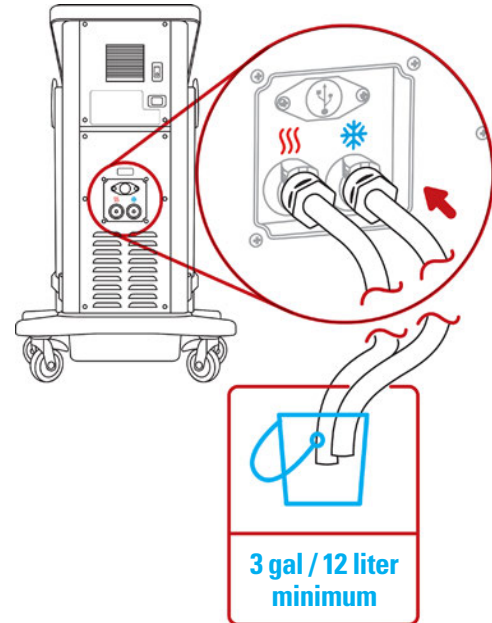

4. Drain the water into the container and dispose of liquid.

To refill the reservoirs:

1. Power off the Med4 Elite by pressing the green On/Off button on the Control Unit screen and the Power off switch on the back of the unit.
2. Locate the reservoir opening. It is located below the touchscreen on the Control Unit. Open by pressing on the cover to release the latch and lift.

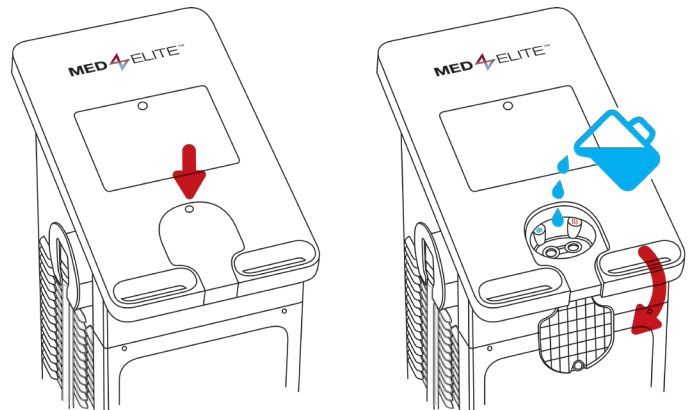

3. Clear any debris from the fill ports.
4. Carefully pour distilled water into the reservoir opening. Two gallons (eight liters) of distilled water are needed to completely fill the reservoirs.

IMPORTANT: Use distilled water only. DO NOT use deionized water or tap water. Failure to use distilled water may void the warranty of the device.

5. When finished filling the reservoirs, close the cover. Press firmly to engage the latch.
6. To turn the Control Unit on, move the power switch on the back of the Control Unit to the on position.

The On/Off button will illuminate in amber color.

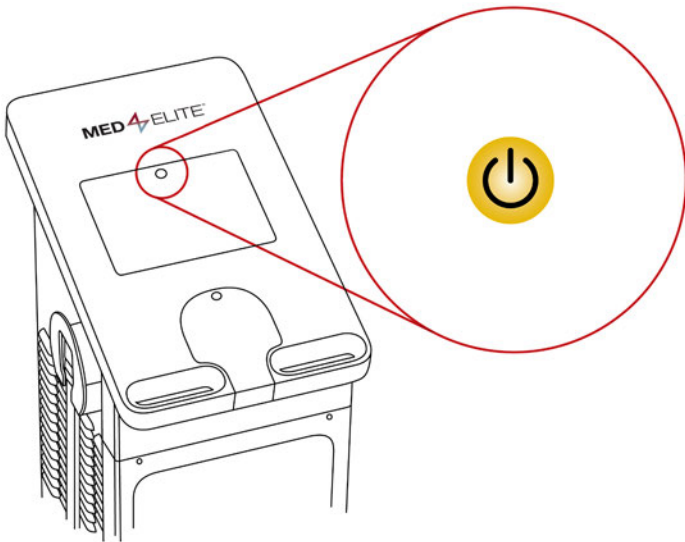

7. Press the On/Off button to boot the computer operating system. The button turns green.

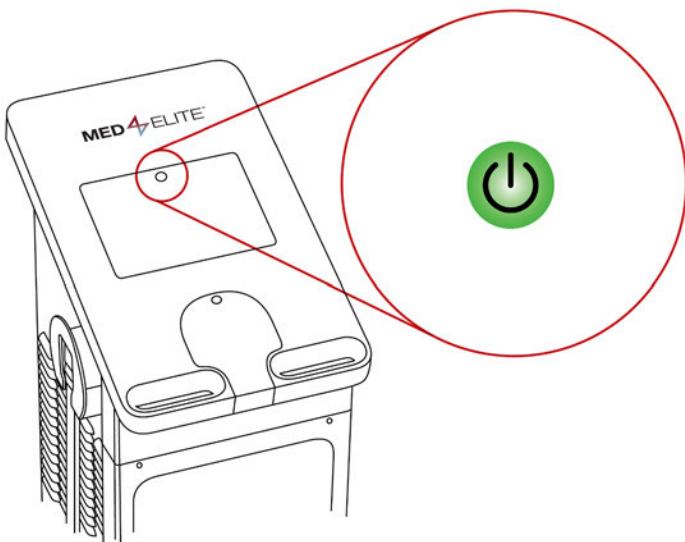

Once reservoirs are full and the Med4 Elite has powered on, the Control Unit heats and cools the water in the reservoirs to the default temperatures. This process takes approximately 15 minutes.

CONTROL UNIT FILTER (EVERY THREE MONTHS)

1. Open the cover on the front of the Control Unit by loosening the screws located at the top corners of the cover. To loosen, push screws in and turn.
2. Remove the filter.

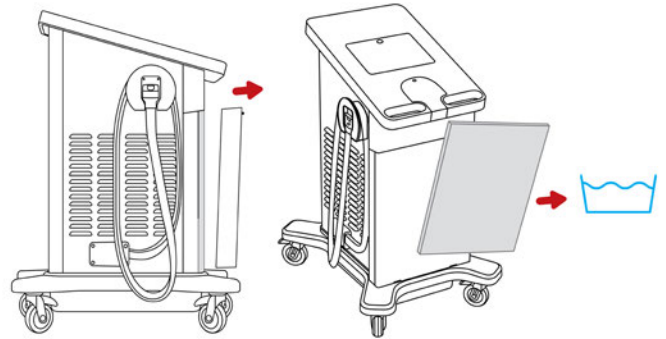

3. Rinse the filter off with water, shake off excess moisture, hang to dry and place it back into the Control Unit.
4. Replace the filter by inserting back into place.
5. Close the cover. Tighten screws by pushing screws in and turning.

Replace filter as needed. Replacement filters may be ordered by contacting Game Ready Customer Service.

WRAPS

To ensure long-term use of the Wraps and to keep them free from dust and contamination, we recommend regular wiping down and gentle cleaning.

To clean the Wraps:

1. Gently remove the Heat Exchanger from the Sleeve.

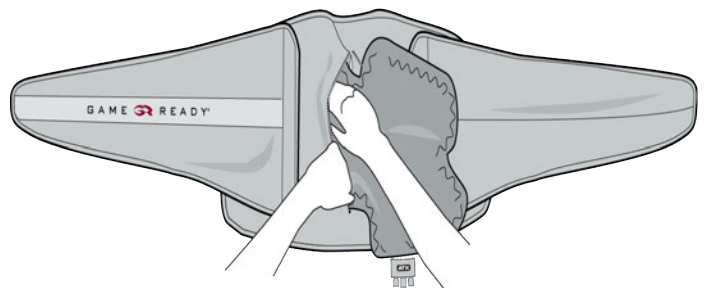

- Hand wash the Sleeve in cold water, using a mild detergent or antibacterial soap.

IMPORTANT: Do not use fabric softener.

- Hang Sleeve to dry.
- If needed, you can hand wash the external surface of the Heat Exchanger, using a very small amount of mild detergent or antibacterial soap.
- Hang Heat Exchanger to dry.

IMPORTANT: For Heat Exchangers: Do not machine wash, and do not place in dryer.

Refer to the Use Guide included with each Wrap for additional details.

ADDING DISTILLED WATER

To add distilled water to the Med4 Elite reservoirs between maintenance (every two weeks), or for a Low Water Alarm, follow these procedures:

- Locate the reservoir opening. It is located below the touchscreen on the Control Unit. Open by pressing on the cover to release the latch and lift.
- Clear any debris from the Fill Port screens.
- Carefully pour distilled water into the reservoir opening until the GUI registers the water level at 75% for both reservoirs. See example below.

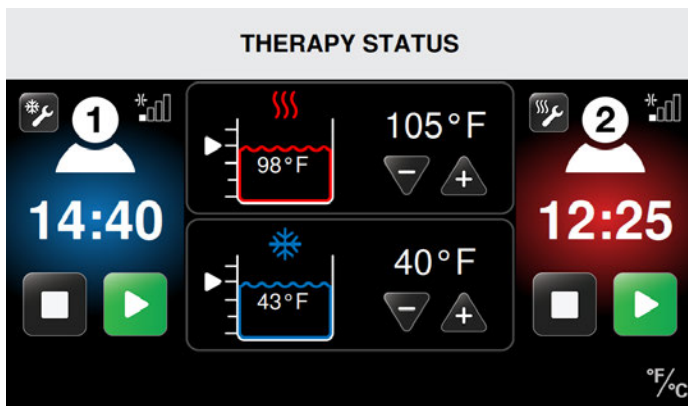

- When finished filling the reservoirs, close the cover. Press firmly to engage the latch.

IMPORTANT: Do not overfill the reservoirs. Pour slowly, and monitor the level indicated on the GUI.

WATER RESERVOIR LEVELS

The Med4 Elite has two water reservoirs that are used to achieve the desired therapy temperature. The GUI indicates the current water level of each reservoir with the following graphics.

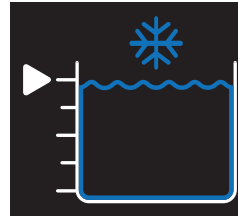

Cold Reservoir 100%

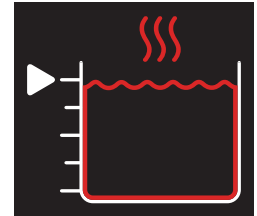

Heat Reservoir 100%

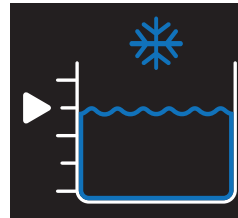

Cold Reservoir 75%

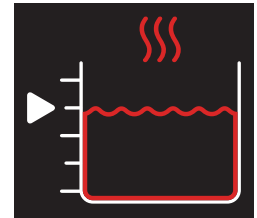

Heat Reservoir 75%

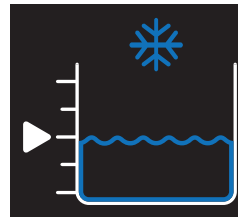

Cold Reservoir 50%

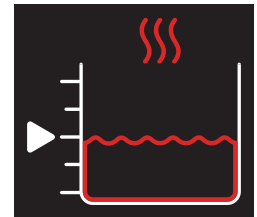

Heat Reservoir 50%

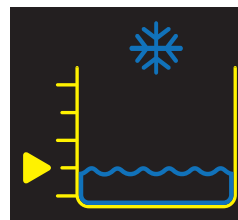

Cold Reservoir 25%

Add Water Soon
(See Alarms)

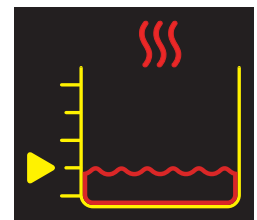

Heat Reservoir 25%

Add Water Soon
(See Alarms)

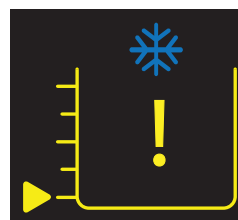

Cold Reservoir Empty

Add Water to Continue
(See Alarms)



Heat Reservoir Empty

Add Water to Continue
(See Alarms)

TRANSPORTING THE MED4 ELITE

MOVING WITHIN THE FACILITY

1. Power off the Control Unit by moving the power switch on the back of the Control unit to the off position.
2. Unplug the Control Unit power cord from the wall outlet.
3. Wrap the Hose once around the Hose hanger and place the end into the holster. Ensure the numbered Hose Connector corresponds with the number on the Hose hanger.
4. Unplug the power cord from the back of the Control Unit.
5. Unlock the wheel casters, and using the handles, move the Control unit to its new location.
6. Once the Control Unit is located in the new location, make sure to lock the four casters in place.

TRANSPORTING IN A VEHICLE

1. Follow instructions in the *Storing* section: *To Store the Control Unit if it will not be in use for more than two weeks.*
2. The Med4 Elite should always be transported upright and never on its side.
3. Use Proper care and shipping materials to protect and secure the Control Unit during transport.
4. The Med4 Elite Travel Case or its original shipping container is recommended for transportation of the Control Unit to prevent damage.

If the Control Unit is damaged during transport and proper care and appropriate shipping materials are not used, the warranty may be voided.

DISPOSING

The cooling system in your Med4 Elite contains R-134a, a refrigerant covered by the United States Environmental Protection Agency's (EPA) disposal regulations and potentially other international environmental agencies. To avoid confusion and potential environmental damage, contact your local waste facility and inquire about disposal procedures for the Med4 Elite.













There are no special disposal requirements for the Wraps.

IMPORTANT MESSAGES

The Med4 Elite reservoirs are shared between patients. When two patients are being treated with therapies that use the same reservoir, the therapy temperature will be the same for both patients.

When setting up a therapy for the second patient, the therapy temperature selection (+ or -) will be inactive. The reservoir

temperature will remain at the temperature set for the first patient. If a different temperature is desired, all therapies must first be paused in order to adjust the reservoir temperature. Attempting to change the temperature while a therapy is in progress will display the Heat/Cold Reservoir in Use message.

Message	What Does it Mean?	What Can I Do?
<div data-bbox="126 556 602 747" style="background-color: black; color: white; padding: 5px;">  HEAT RESERVOIR IN USE The heat temperature must be the same for both patients. To change the heat temperature all therapy using the heat reservoir must be paused.  See user manual for more information TOUCH TO HIDE MESSAGE  </div> <p style="text-align: center;">or</p> <div data-bbox="228 884 500 1129" style="background-color: black; color: white; padding: 5px;">  HEAT RESERVOIR IN USE The heat temperature must be the same for both patients. To change the heat temperature all therapy using the heat reservoir must be paused.  See the user manual for more information TOUCH TO HIDE MESSAGE  </div>	<p style="text-align: center;">Heat Reservoir in Use</p> <p>An attempt has been made to adjust the Heat Reservoir Temperature while a therapy that uses the heat reservoir (Heat or Rapid Contrast) is currently in progress.</p> <p>The Control Unit has not interrupted therapy for either user.</p>	<ul style="list-style-type: none"> Pause treatment on the first patient, and adjust the temperature (This adjusted temperature will be the same for BOTH patients.) Resume therapy for the first patient by pressing the Start button. Set up the second patient and press the Start button to begin therapy.
<div data-bbox="126 1222 602 1413" style="background-color: black; color: white; padding: 5px;">  COLD RESERVOIR IN USE The cold temperature must be the same for both patients. To change the cold temperature all therapy using the cold reservoir must be paused.  See user manual for more information TOUCH TO HIDE MESSAGE  </div> <p style="text-align: center;">or</p> <div data-bbox="228 1549 500 1795" style="background-color: black; color: white; padding: 5px;">  COLD RESERVOIR IN USE The cold temperature must be the same for both patients. To change the cold temperature all therapy using the cold reservoir must be paused.  See the user manual for more information TOUCH TO HIDE MESSAGE  </div>	<p style="text-align: center;">Cold Reservoir in Use</p> <p>An attempt has been made to adjust the Cold Reservoir Temperature while a therapy that uses the cold reservoir (Cold or Rapid Contrast) is currently in progress.</p> <p>The Control Unit has not interrupted therapy for either user.</p>	<ul style="list-style-type: none"> Pause treatment on the first patient, and adjust the temperature (This adjusted temperature will be the same for BOTH patients.) Resume therapy for the first patient by pressing the Start button. Set up the second patient and press the Start button to begin therapy.

Need more help with a problem? In the U.S. call Game Ready Customer Service at 1.888.GameReady (1.888.426.3732) or 1.510.868.2100. From outside of the U.S., please contact your local distributor.

ALARMS

The Med4 Elite self-monitors for events that impede its proper operation. If an event occurs, the Control Unit triggers an alarm. These alarms are easy to reset, using the simple instructions listed below.

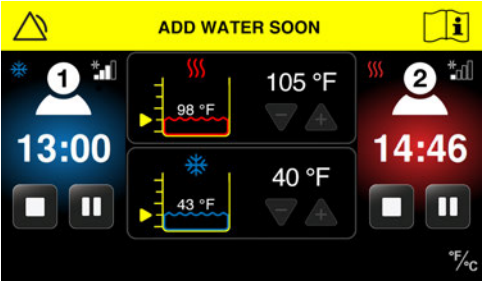
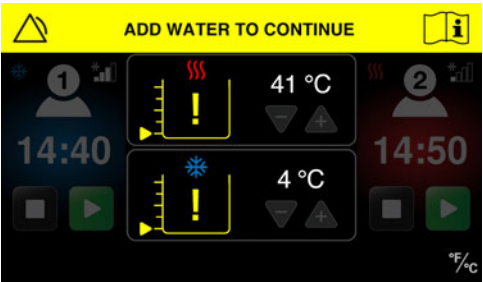
Alarm	What Does it Mean?	What Can I Do?
	<p>Add Water Soon</p> <p>The Control Unit has detected that the water level of either reservoir has been below 50% for 20 seconds.</p> <p>The Control Unit has not interrupted therapy for either user.</p>	<ul style="list-style-type: none"> • Add distilled water into either reservoir inlet, located just below the touch screen on the Control Unit. Water may be added while the Control Unit is turned on. • Alarm turns off when the reservoir levels reach 75% for 10 seconds. • The therapy session continues.
	<p>Add Water to Continue</p> <p>The Control Unit has detected that the water level of either reservoir has been below 25% for 10 seconds.</p> <p>The Control Unit has paused therapy for both users until the reservoirs are filled.</p> <p>Therapy session(s) can be restarted or stopped.</p>	<ul style="list-style-type: none"> • Add distilled water into either reservoir inlet, located just below the touch screen on the Control Unit. Water may be added while the Control Unit is turned on. • Alarm turns off when the reservoir levels reach 75%. • Therapy sessions remain paused. • Continue therapy after filling the reservoirs by pressing the Start button for Patient(s). • Pressing the Stop button will end the therapy session.

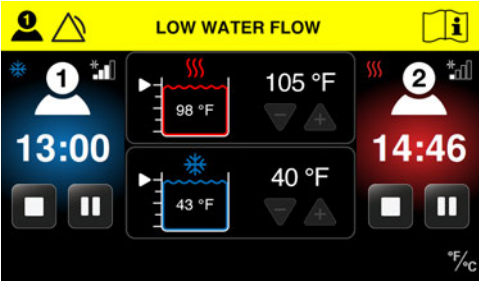
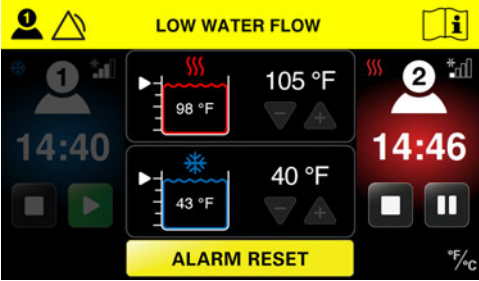
Alarm	What Does it Mean?	What Can I Do?
	<p>Low Water Flow Patient 1</p> <p>The Control Unit has detected low water flow for Patient 1.</p> <p>The Control Unit has not interrupted therapy for either user.</p>	<ul style="list-style-type: none"> • Check Wrap for kinks, other obstructions or leaks. • If alarm persists, check the Hose to Patient 1 for kinks, other obstructions or leaks. • Ensure wrap is applied with a snug fit. • If alarm persists, make sure it is securely snapped into the Hose, or try a different Wrap to isolate which component may be producing the error. • Reduce compression level. • Alarm will turn off once obstruction is cleared. • Therapy session(s) continue(s).
	<p>Persistent Low Water Flow Patient 1</p> <p>The Control Unit has detected low water flow for Patient 1 for at least 90 seconds.</p> <p>The Control Unit has paused Patient 1's therapy.</p> <p>If Patient 2's therapy session is in progress, the Control Unit has not interrupted Patient 2's therapy.</p>	<ul style="list-style-type: none"> • Check Wrap for kinks, other obstructions or leaks. • If alarm persists, check the Hose to Patient 1 for kinks, other obstructions or leaks. • Reduce compression level. • Therapy session for blocked user will remain paused. • Push Alarm Reset button. • If alarm persists, make sure the Wrap is securely snapped into the Hose, or try a different Wrap to isolate which component may be producing the error. • Press the Start button for Patient 1 to start therapy, or press the Stop button to stop therapy.

Need more help with a problem? In the U.S. call Game Ready Customer Service at 1.888.GameReady (1.888.426.3732) or 1.510.868.2100. From outside of the U.S., please contact your local distributor.

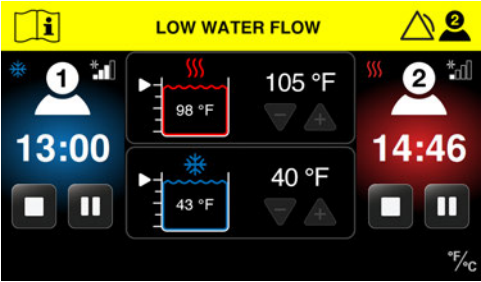
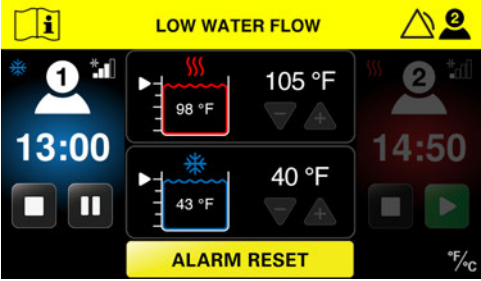
Alarm	What Does it Mean?	What Can I Do?
	<p>Low Water Flow Patient 2</p> <p>The Control Unit has detected low water flow for Patient 2.</p> <p>The Control Unit has not interrupted therapy for either user.</p>	<ul style="list-style-type: none"> • Check Wrap for kinks, other obstructions or leaks. • If alarm persists, check the Hose to Patient 2 for kinks, other obstructions or leaks. • Ensure wrap is applied with a snug fit. • If alarm persists, make sure the Wrap is securely snapped into the Hose, or try a different Wrap to isolate which component may be producing the error. • Reduce compression level. • Alarm will turn off once obstruction is cleared. • Therapy session(s) continue(s).
	<p>Persistent Low Water Flow Patient 2</p> <p>The Control Unit has detected low water flow for Patient 2 for at least 90 seconds.</p> <p>The Control Unit has paused Patient 2's therapy.</p> <p>If Patient 1's therapy session is in progress, the Control Unit does not pause Patient 1's therapy.</p>	<ul style="list-style-type: none"> • Check Wrap for kinks, other obstructions or leaks. • If alarm persists, check the Hose to Patient 2 for kinks, other obstructions or leaks. • Reduce compression level • Therapy session for blocked user will remain Paused. • Push Alarm Reset button. • If alarm persists, make sure the Wrap is securely snapped into the Hose, or try a different Wrap to isolate which component may be producing the error. • Press the Start button for Patient 2 to start therapy, or press the Stop button to stop therapy.

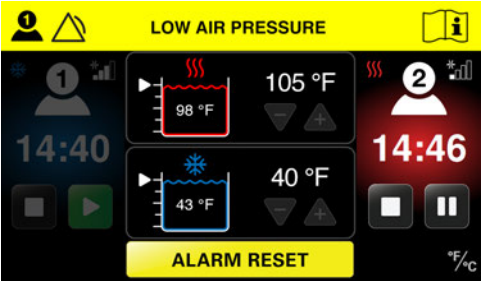
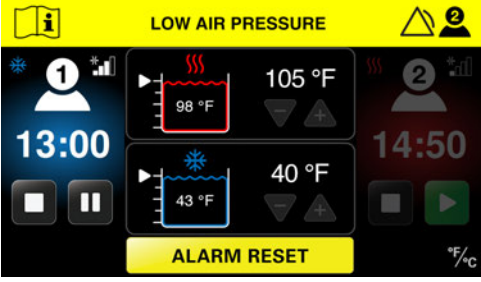
Alarm	What Does it Mean?	What Can I Do?
	<p style="text-align: center;">Low Air Pressure Patient 1</p> <p>The Control Unit has detected that Patient 1 has had low air pressure for at least 30 seconds beyond expected time to reach peak pressure.</p> <p>The Control Unit has paused Patient 1's therapy.</p> <p>If Patient 2's therapy session is in progress, The Control Unit has not paused Patient 2's.</p>	<ul style="list-style-type: none"> • Check that Wrap has been applied correctly (hook and loop should be attached). • Remove Wrap from connector and deflate by pressing it flat to expel air. • Try again. • Push Alarm Reset button. • If this does not correct the problem, check for air leaks in the Hose or Wrap. • To help isolate the problem, try a different wrap. <p><i>If you find air leaks, contact Game Ready support or your local distributor for further assistance.</i></p> <ul style="list-style-type: none"> • After pressing Alarm Reset, press Patient 1's Start button to restart therapy, or the Stop button to stop therapy.
	<p style="text-align: center;">Low Air Pressure Patient 2</p> <p>The Control Unit has detected that Patient 2 has had low air pressure for at least 30 seconds beyond expected time to reach peak pressure.</p> <p>The Control Unit has paused Patient 2's therapy.</p> <p>If Patient 1's therapy session is in progress, The Control Unit has not paused Patient 1's.</p>	<ul style="list-style-type: none"> • Check that Wrap has been applied correctly (hook and loop should be attached). • Remove Wrap from connector and deflate by pressing it flat to expel air. • Try again. • Push Alarm Reset button. • If this does not correct the problem, check for air leaks in the Hose or Wrap. • To help isolate the problem, try a different wrap. <p><i>If you find air leaks, contact Game Ready support or your local distributor for further assistance.</i></p> <ul style="list-style-type: none"> • After pressing Alarm Reset, press Patient 2's Start button to restart therapy, or the Stop button to stop therapy.

Need more help with a problem? In the U.S. call Game Ready Customer Service at 1.888.GameReady (1.888.426.3732) or 1.510.868.2100. From outside of the U.S., please contact your local distributor.

ERROR CODES

If the Med4 Elite plays an alarm tone and displays an error message during a therapy session, the Control Unit will turn off the power supply. Make note of the error code, and in the U.S. contact Game Ready Technical Support at 1.888.GameReady (1.888.426.3732) or 1.510.868.2100. From outside the U.S., contact your local distributor.

NOTE: The error code will be shown in the title bar.

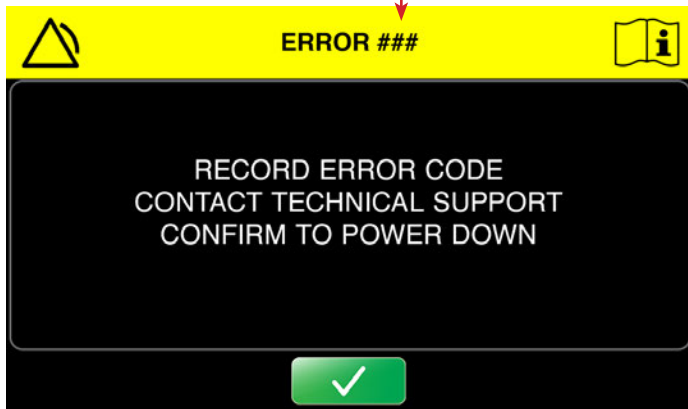

REPAIRING THE MED4 ELITE

In the event that the Med4 Elite requires repair, such work must be performed by a Game Ready authorized agent. Do not attempt to repair the Control Unit. Unauthorized repairs will void the warranty.

Device contains R-134a refrigerant, to be serviced by qualified technicians only. Contact Game Ready Technical Support. In the U.S. call 1.888. GameReady (1.888.426.3732) or 1.510.868.2100. Outside the U.S., contact your local distributor.

MED4 ELITE PRODUCT SPECIFICATIONS

Dimensions	32.5" L x 24.75" W x 43" H (83 cm L x 63 cm W x 109 cm H)
Weight when Reservoirs are empty	159 lb (72 kg)
Weight when Reservoirs are full	174 lb (79 kg)
Input Voltage	100–240 V~, 50–60 Hz
Input Power	1200 VA
Heat Reservoir Temperature Range	95–113 °F (35–45 °C)
Cold Reservoir Temperature Range	38–60 °F (3.33–15.56 °C)
Ambient Operating Environment	50–90 °F (10–32 °C) 30–90% non-condensing
Storage Temperature and Humidity	33–122 °F (1–50 °C) 10–95% non-condensing
Operating Altitude Range	0–9,842 ft (0–3,000 m)
Reservoir Capacities	Heat Reservoir: 1 gallon (3.8 liters) Cold Reservoir: 1 gallon (3.8 liters)
Reservoir Temperature:	Maximum Heat Reservoir Temperature: 113 °F (45 °C) Minimum Cold Reservoir Temperature: 38 °F (3 °C) Water Temperature Accuracy: ± 4 °F (± 2 °C)
Intermittent Pneumatic Compression	No compression: Wrap shall be vented to atmosphere Low: 5–15 mmHg Medium-Low: 5–30 mmHg Medium: 5–50 mmHg High: 5–75 mmHg Air Pressure Accuracy: ± 10 mmHg Bottom of pressure ramp: 5 mmHg

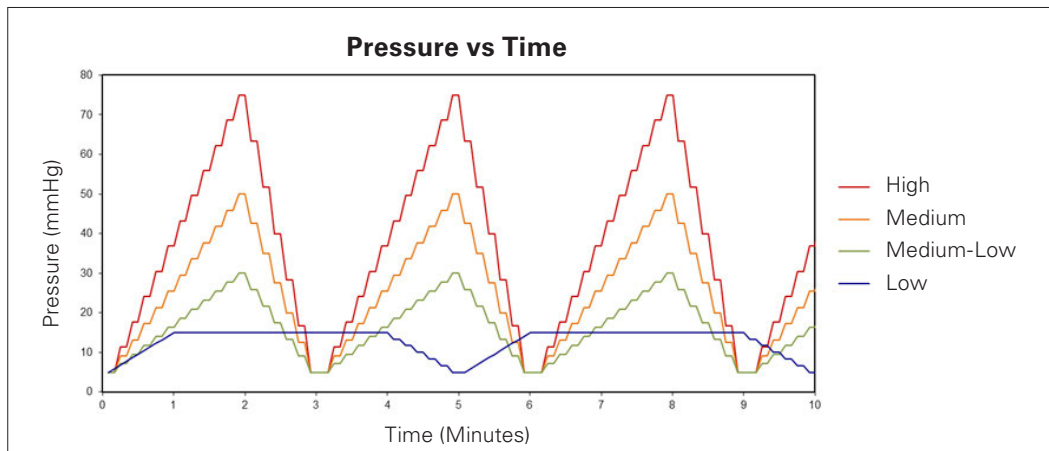

The ranges above represent the cyclical compression that the Med4 Elite delivers. For example, Low compression starts at a low end level of 5 mmHg and reaches its peak compression at 15 mmHg. The Control Unit cycles from bottom to top of pressure ramp repeatedly until the therapy session time runs out.

SUPPLIED POWER CORD SPECIFICATIONS

Medical Grade Power Cord Game Ready PN 303835 Canada Mexico United States	Cordage	14 AWG / 3C, SJTW, Temp Rating 105 °C
	Rating	125V, 15A
	Plug	NEMA 5-15P
	Connector	IEC 60320 C19
	Approvals	UL, C-UL
		RoHS Compliant

Power Cord Game Ready PN 303839 India	Cordage	H05VV-F 3G 0.75 mm ²
	Rating	250V, 16A
	Plug	IS 6538 India
	Connector	IEC 60320 C19
	Approvals	BIS
		RoHS Compliant

Power Cord Game Ready PN 303836 Finland France Germany Greece Netherlands Poland Russia Spain Sweden Turkey	Cordage	K60227 IEC53 3G 1.5 mm ² + H05VV-F 3G 1.5 mm ²
	Rating	250V, 16A
	Plug	CEE 7/7 European Schuko
	Connector	IEC 60320 C19
	Approvals	European.CE+KC, VDE+KC, EAC
		RoHS Compliant

Power Cord Game Ready PN 303840 Switzerland	Cordage	H05VV-F 3G 1.5 mm ²
	Rating	250V, 10A
	Plug	SEV 1011 Swiss
	Connector	IEC 60320 C19
	Approvals	European, CE, SEV
		RoHS Compliant

Power Cord Game Ready PN 303837 Hong Kong Kuwait Saudi Arabia United Arab Emirates United Kingdom	Cordage	H05VV-F 3G 1.5 mm ²
	Rating	250V, 13A
	Plug	BS1363 UK13
	Connector	IEC 60320 C19
	Approvals	European.CE, BSI+PSB
		RoHS Compliant

Power Cord Game Ready PN 303841 Brazil	Cordage	IEC 60227-5 60227 IEC 53 3G 1.5 mm ²
	Rating	250V, 10A
	Plug	NBR 14136 Brazil
	Connector	IEC 60320 C19
	Approvals	INMETRO
		RoHS Compliant

Power Cord Game Ready PN 303838 Chile Italy	Cordage	H05VV-F 3G 1.5 mm ²
	Rating	250V, 16A
	Plug	CEI 23-16 Italian
	Connector	IEC 60320 C19
	Approvals	EUROPEAN, VDE
		RoHS Compliant

Power Cord Game Ready PN 303842 Argentina	Cordage	H05VV-F 3G 1.5 mm ²
	Rating	250V, 10A
	Plug	IRAM 2073:2009 Argentina
	Connector	IEC 60320 C19
	Approvals	European, VDE, CE
		RoHS Compliant

Power Cord Game Ready PN 303843 Australia	Cordage	H05VV-F 3G 1.5 mm ²
	Rating	250V, 15A
	Plug	AS/NZS 4417 Australia 15A
	Connector	IEC 60320 C19
	Approvals	European, SAA
		RoHS Compliant

Power Cord Game Ready PN 303847 Korea	Cordage	K60227 IEC53 3C 1.5 mm ²
	Rating	250V, 16A
	Plug	KSC 8305 Korean
	Connector	IEC 60320 C19
	Approvals	KC
		RoHS Compliant

Power Cord Game Ready PN 303844 Denmark	Cordage	H05VV-F 3G 1.5 mm ²
	Rating	250V, 10A
	Plug	SRAF 1962/DB 16/87 Danish
	Connector	IEC 60320 C19
	Approvals	European, VDE
		RoHS Compliant

IMPORTANT: Use only Game Ready supplied Power Cord. Only the Power Cord suitable for your country will be included with Med4 Elite.

Replacement power cords can be purchased through your local authorized Game Ready Representative or by contacting Game Ready Customer Service. In the U.S. call 1.888. Game Ready (1.888.426.3732) or +1.510.868.2100. Outside the U.S., contact your local distributor for additional parts. See *Accessories and Replacement Parts* for additional parts and accessories.

Power Cord Game Ready PN 303845 Israel	Cordage	H05W-F 3G 1.5 mm ²
	Rating	250V, 16A
	Plug	SI 32 Israel
	Connector	IEC 60320 C19
	Approvals	VDE, CE
		RoHS Compliant

Power Cord Game Ready PN 303846 Japan	Cordage	VCTF 3C 2.0 mm ²
	Rating	125V, 15A
	Plug	JIS 8303 Japan
	Connector	IEC 60320 C19
	Approvals	PSE
		RoHS Compliant

UL CLASSIFICATION

Classification:	CLASS I ME EQUIPMENT
Applied Part Type:	TYPE B APPLIED PART
Protection against electric shock:	<p>THE MED4 ELITE SYSTEM IS CONSIDERED TO BE CLASS I (PROTECTIVELY EARTHED)</p> <div style="display: flex; align-items: center;">  <p>MED4 ELITE SYSTEM: GENERAL MEDICAL EQUIPMENT AS TO ELECTRICAL SHOCK, FIRE AND MECHANICAL HAZARDS ONLY IN ACCORDANCE WITH ANSI/AAMI ES60601-1:2005/(R)2012 and CAN/CSA- C22.2 No. 60601-1:2014</p> </div>
Protection against harmful ingress of water:	This product is categorized as IPX0.
Pollution Degree Classification:	This product is classified as Pollution degree 2.
Degree of safety in the presence of flammable anesthetics or oxygen:	Not suitable for use in an oxygen enriched environment or in the presence of flammable anesthetics.

ESSENTIAL PERFORMANCE

The Essential Performance of the Med4 Elite System is:

INTERMITTENT PNEUMATIC COMPRESSION CYCLES

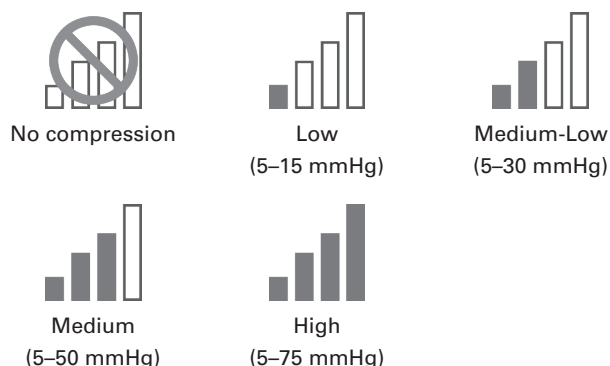

Air Pressure Accuracy: ± 10 mmHg

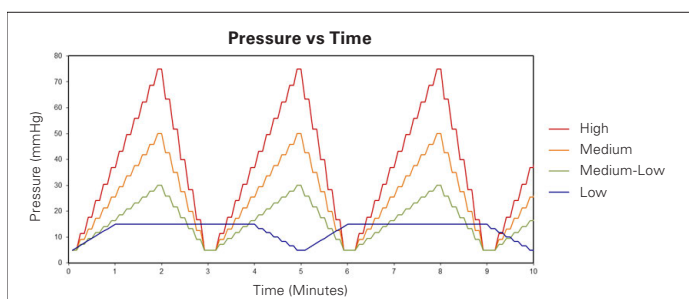

TEMPERATURE CONTROL

- Cold Therapy: The Cold Reservoir temperature will be adjustable between 38–60 °F (3.33–15.56 °C)
- Heat Therapy: The Heat Reservoir temperature will be adjustable between 95–113 °F (35–45 °C)
- Rapid Contrast Therapy: Alternates between Cold Therapy and Heat Therapy. See above for ranges.
- Compression-Only Therapy: Temperature control does not apply.

Water Temperature Accuracy: ± 4 °F (± 2 °C)

If Essential Performance is lost, the device may display an Alarm screen or Error message, may stop therapy, and/or may shut down.

ELECTROMAGNETIC COMPATIBILITY

The Med4 Elite complies with the appropriate IEC 60601-1-2 specifications regarding electromagnetic compatibility. Ensure that the Med4 Elite is installed and used according to the electromagnetic compatibility information provided.

- **WARNING:** Use of accessories or cables other than those specified or provided by the manufacturer of this equipment could result in increased electromagnetic emissions or decreased electromagnetic immunity of this equipment and result in improper operation.
- **WARNING:** Use of this equipment adjacent to or stacked with other equipment should be avoided because it could result in improper operation. If such use is necessary, this equipment and the other equipment should be observed to verify that they are operating normally.
- **WARNING:** Portable RF communications equipment (including peripherals such as antenna cables and external antennas) should be used no closer than 30 cm (12 inches) to any part of the Med4 Elite. Otherwise, degradation of the performance of this equipment could result.
- **NOTE:** The emissions characteristics of this equipment make it suitable for use in industrial areas and hospitals (CISPR 11 class A). If it is used in a residential environment (for which CISPR 11 class B is normally required) this equipment might not offer adequate protection to radio-frequency communication services. The user might need to take mitigation measures, such as relocating or re-orienting the equipment.

Guidance and Manufacturer's Declaration for Electromagnetic Emissions:	
Emissions Test	Compliance
Conducted and radiated RF emissions	CISPR 11 Group 1 Class A
Harmonic distortion	CISPR 11 Group 1 Class A. See IEC 61000-3-2.
Voltage fluctuations and flicker	CISPR 11 Group 1 Class A. See IEC 61000-3-3.

Guidance and Manufacturer's Declaration for Electromagnetic Immunity:			
Immunity Test	Basic EMC standard or test method	Immunity Test Levels	Compliance Levels
Electrostatic Discharge	IEC 61000-4-2	± 8kV contact	± 8kV contact
		± 2kV, ± 4kV, ± 8kV, ± 15kV air	± 2kV, ± 4kV, ± 8kV, ± 15kV air
Radiated RF EM Fields	IEC 61000-4-3	3 V/m 80 MHz – 2.7 GHz 80% AM at 1 kHz	3 V/m 80 MHz – 2.7 GHz 80% AM at 1 kHz
Proximity Fields From RF Wireless Communications Equipment	IEC 61000-4-3	See table	See table
Rated Power Frequency Magnetic Fields	IEC 61000-4-8	30 A/m 50 Hz or 60 Hz	30 A/m 50 Hz or 60 Hz
Electrical Fast Transients / Bursts	IEC 61000-4-4	± 2kV 100 kHz repetition frequency	± 2kV 100 kHz repetition frequency
Surges Line-to-Line	IEC 61000-4-5	± 0.5kV, ± 1kV	± 0.5kV, ± 1kV
Surges Line-to-Ground	IEC 61000-4-5	± 0.5kV, ± 1kV, ± 2kV	± 0.5kV, ± 1kV, ± 2kV
Conducted Disturbances induced by RF Fields	IEC 61000-4-6	3 V 0.15 MHz – 80 MHz 6V in ISM bands between 0.15 MHz and 80 MHz 80% AM at 1 kHz	3 V 0.15 MHz – 80 MHz 6V in ISM bands between 0.15 MHz and 80 MHz 80% AM at 1 kHz
Voltage Dips	IEC 61000-4-11	0% U_T ; 0.5 cycle At 0°, 45°, 90°, 135°, 180°, 225°, 270°, and 315° 0% U_T ; 1 cycle and 70% U_T ; 25/30 cycles Single phase: at 0°	0% U_T ; 0.5 cycle At 0°, 45°, 90°, 135°, 180°, 225°, 270°, and 315° 0% U_T ; 1 cycle and 70% U_T ; 25/30 cycles Single phase: at 0°
Voltage Interruptions	IEC 61000-4-11	0% U_T ; 250/300 cycle	Device will power down and/or reboot if power is interrupted for five seconds.
Note: U_T is the AC mains voltage prior to the application of the test level			

Proximity Fields From RF Wireless Communications Equipment						
Test Frequency (MHz)	Band	Service	Modulation	Maximum Power (W)	Distance (m)	Immunity Test Level (V/m)
385	380-390	TETRA 400	Pulse modulation 18 Hz	1.8	0.3	27
450	430-470	GMRS 460, FRS 460	FM \pm 5kHz deviation 1 kHz sine	2	0.3	28
710	704-787	LTE Band 13, 17	Pulse modulation 217 Hz	0.2	0.3	9
745						
780						
810	800-960	GSM 800/900, TETRA 800, iDEN 820, CDMA 850, LTE Band 5	Pulse modulation 18 Hz	2	0.3	28
870						
930						
1720	1700-1990	GSM 1800, CDMA 1900, GSM 1900, DECT, LTE Band 1, 3, 4, 25, UMTS	Pulse modulation 217 Hz	2	0.3	28
1845						
1970						
2450	2400-2570	Bluetooth, WLAN, 802.11 b/g/n, RFID 2450, LTE Band 7	Pulse modulation 217 Hz	2	0.3	28
5240	5100-5800	WLAN 802.11 a/n	Pulse modulation 217 Hz	0.2	0.3	9
5500						
5785						

ACCESSORIES AND REPLACEMENT PARTS

Accessories and Replacement Parts can be purchased through your local authorized Game Ready Representative or by contacting Game Ready Customer Service. In the U.S. call 1.888. Game Ready (1.888.426.3732) or +1.510.868.2100. Outside the U.S., contact your local distributor.

ACCESSORIES

- Game Ready ATX® Series Wraps are available in various sizes for various parts of the body including: shoulder, elbow, hand/wrist, back, hip/groin, knee, leg, and ankle.
- Custom Med4 Elite Travel Case for transporting Control Unit

To view a complete list of products visit www.gameready.com.

REPLACEMENT PARTS

- Connector Hose
- Filter
- Reservoir Fill Port Screens
- Drain Hose
- Power Cord

NOTE: Only Game Ready accessories and replacement parts should be used with the Med4 Elite. Using products with the Med4 Elite other than Game Ready products may void the Med4 Elite Warranty.

WARRANTY

MANUFACTURER'S LIMITED WARRANTY

CoolSystems warrants that the Med4 Elite (including the Connector Hoses and Power Cord), if properly used, will be free from defects in material and workmanship for a period of two (2) years after the date the Med4 Elite was purchased. If the Med4 Elite, which is the subject of this Limited Warranty, malfunctions during the warranty period for reasons covered by this Limited Warranty, CoolSystems, at its sole option, will:

- REPAIR the Med4 Elite
OR
REPLACE the Med4 Elite with another Med4 Elite.

EXTENT OF LIMITED WARRANTY

CoolSystems may elect to replace or repair the Med4 Elite with either a new or reconditioned product. The returned product shall become CoolSystems' property upon receipt. The replacement Med4 Elite is warranted under this written warranty and is subject to the same limitations and exclusions for the remainder of the original warranty period. THIS LIMITED WARRANTY APPLIES ONLY TO THE ORIGINAL PURCHASER OF THE Med4 Elite AND IS NOT TRANSFERABLE.

LIMITED WARRANTY EXCLUSIONS

This limited warranty does not cover damages due to external causes, including, without limitation, storage, usage or handling not in accordance with product instructions, accident, misuse, neglect, or alteration, or an unauthorized repair.

HOW TO OBTAIN WARRANTY SERVICE

To obtain warranty service, in the U.S. call Game Ready Customer Service at 1.888.426.3732 (+1.510.868.2100); from outside of the U.S. please contact your local distributor. If you are not sure who the local distributor is, call Game Ready Customer Service at +1.510.868.2100 and we will refer you to one. You must have registered the product online with CoolSystems within thirty (30) days from the date of purchase to qualify for warranty service. If you qualify for warranty service from CoolSystems, CoolSystems, or its distributor, will schedule an authorized service technician to provide on-site repair. If CoolSystems authorizes the return of the Med4 Elite, you will be issued a Return Material Authorization (RMA) number. You should keep this RMA number for your records. CoolSystems, or its distributor, will make arrangements for the shipment of the Med4 Elite to CoolSystems (at CoolSystems expense). Customer is not to return the Med4 Elite without prior written authorization from CoolSystems. CoolSystems may require you to verify in writing that you are the original purchaser of the Med4 Elite.

WARRANTY DISCLAIMERS

THESE WARRANTIES ARE IN LIEU OF ANY AND ALL OTHER WARRANTIES, EXPRESS OR IMPLIED INCLUDING, BUT NOT LIMITED TO, THE IMPLIED WARRANTIES OF MERCHANTABILITY AND FITNESS FOR A PARTICULAR PURPOSE. COOLSYSTEMS MAKES NO EXPRESS WARRANTIES BEYOND THOSE STATED HERE. COOLSYSTEMS DISCLAIMS ALL OTHER WARRANTIES, EXPRESS OR IMPLIED INCLUDING, WITHOUT LIMITATION, IMPLIED WARRANTIES OF MERCHANTABILITY AND FITNESS FOR A PARTICULAR PURPOSE. SOME JURISDICTIONS DO NOT ALLOW THE EXCLUSION OF IMPLIED WARRANTIES SO THIS LIMITATION MAY NOT APPLY TO YOU. ALL EXPRESS AND IMPLIED WARRANTIES ARE LIMITED IN DURATION TO THE LIMITED WARRANTY PERIOD. NO WARRANTIES APPLY AFTER THAT PERIOD. SOME JURISDICTIONS DO NOT ALLOW LIMITATIONS ON HOW LONG AN IMPLIED WARRANTY LASTS, SO THIS LIMITATION MAY NOT APPLY TO YOU.

LIMITATIONS OF LIABILITY

COOLSYSTEMS' RESPONSIBILITY UNDER THIS, OR ANY OTHER WARRANTY, IMPLIED OR EXPRESS, IS LIMITED TO REPAIR OR REPLACEMENT, AS SET FORTH ABOVE. THESE REMEDIES ARE THE SOLE AND EXCLUSIVE REMEDIES FOR ANY BREACH OF WARRANTY. IN NO EVENT SHALL COOLSYSTEMS BE LIABLE TO ANY PERSON FOR ANY INCIDENTAL, SPECIAL, PUNITIVE OR CONSEQUENTIAL DAMAGES, INCLUDING LOST PROFITS, COST OF PROCUREMENT OF SUBSTITUTE GOODS, DOWNTIME, GOODWILL, DAMAGE TO OR REPLACEMENT OF EQUIPMENT OR PROPERTY OR ANY INDIRECT DAMAGES EVEN IF COOLSYSTEMS HAS BEEN INFORMED OF THE POSSIBILITY THEREOF AND NOTWITHSTANDING THE FAILURE OF ESSENTIAL PURPOSE OF ANY LIMITED REMEDY STATED HEREIN. SOME JURISDICTIONS DO NOT ALLOW THE EXCLUSION OR LIMITATION OF INCIDENTAL OR CONSEQUENTIAL DAMAGES, SO THE ABOVE LIMITATIONS OR EXCLUSIONS MAY NOT APPLY TO YOU. THIS LIMITED WARRANTY GIVES YOU SPECIFIC RIGHTS, AND YOU MAY ALSO HAVE OTHER RIGHTS THAT VARY FROM JURISDICTION TO JURISDICTION.

WARRANTY REGISTRATION

Please complete the Warranty Registration within 30 days for the Med4 Elite online at www.gameready.com. Visit the Product Registration page, fill out the form, and submit your information. You will need the following information to complete your Warranty Registration: The Control Unit's model number (REF) and its serial number (SN). These numbers are located on the label on the backside of the Control Unit and may also be found on the Information screen in System Settings.

WARRANTY OF MED4 ELITE ACCESSORIES

Warranty information for Game Ready's Heat Exchangers, Wraps and Sleeves is available at www.gameready.com.

INTELLECTUAL PROPERTY











TRADEMARKS, TRADE NAMES, COPYRIGHTS AND PATENTS







The Med4 Elite and all accessories are covered by intellectual property rights including, but not limited to, trademarks, trade names, copyrights and patents, owned or licensed by CoolSystems. No license under such intellectual property rights are granted to users, and all such rights are hereby expressly reserved by CoolSystems. User shall not (i) modify any Med4 Elite product or documentation CoolSystems provides to user or (ii) reverse engineer, decompile, or disassemble any Med4 Elite product, or encourage or assist any third party in doing so. Certain of CoolSystems trademarks, trade names and copyrights are listed herein.

SOFTWARE LICENSE

Med4 Elite products contain software that is installed in the products by CoolSystems. CoolSystems owns or licenses this software from third parties. Each sale of a Med4 Elite product is not a sale of the software contained therein but rather is only a license to use the software in the Med4 Elite product in which the software was initially installed. Any license granted by CoolSystems to use the software contained in its Med4 Elite products does not give the user/licensee the right to copy, alter, disassemble, reverse engineer, create derivative works of such software or to use such software in either original or modified form in any product other than the Med4 Elite product in which the software was initially installed by CoolSystems.

SYMBOL DESCRIPTIONS

	MED4 ELITE SYSTEM: GENERAL MEDICAL EQUIPMENT AS TO ELECTRICAL SHOCK, FIRE AND MECHANICAL HAZARDS ONLY IN ACCORDANCE WITH ANSI/AAMI ES60601-1:2005/(R)2012 and CAN/CSA- C22.2 No. 60601-1:2014
 100-240 VAC 1200 VA 50-60Hz	Powered by AC Current
	Type B Applied Parts
	Caution: Dangerous voltage (IEC 60417-5036)
	Caution: Fan Finger Hazard. Keep fingers away from blades of fan.
	General Warning
	Qualified Service Technician
	Refrigerant Type
	Refrigerant Amount in grams
	Warning: It is mandatory to fully read and understand the User Manual before using the device. Failure to follow operating instructions could result in serious injury.

	Attention: Consult User Manual
	Stand-by (On/Off button)
	This symbol on the Control Unit or its packaging means that this product must not be disposed of with household/consumer waste. To learn where to drop off your electrical and electronic waste, please contact your local city/municipal waste disposal service office or contact Game Ready for assistance.
	Manufacturer
	Symbol for "Made in" a specific country (USA)
	Symbol for "Assembled in" a specific country (USA)
	Indicates the manufacturer's catalogue number so that the medical device can be identified
	Serial Number
	Unique Device Identifier A UDI is a unique numeric or alphanumeric code that consists of two parts: a fixed device identifier and a variable production identifier (i.e. serial number or lot/batch number)

CORPORATE OFFICES

CoolSystems®, Inc.
 DBA Game Ready®
 1800 Sutter Street, Suite 500
 Concord, California 94520
 USA

PHONE, EMAIL, & FAX

Inside the U.S. Call Toll-Free	1.888.GameReady 1.888.426.3732
Phone	1.510.868.2100
Fax	1.510.559.9402
Email	info@gameready.com
Hours:	Monday–Friday 9:00 a.m. to 5:00 p.m. PST

PRODUCT and TECHNICAL SUPPORT

Inside the U.S. Call Toll-Free	1.888.426.3732, Option 3
---	--------------------------

Representatives are available 24/7 to answer questions about the products and provide troubleshooting assistance.

International customers contact your local distributor.

Game Ready has Authorized Distributors across the globe. Find the closest one to you. Visit www.gameready.com for a list of our International Distributors.



EC	REP
-----------	------------

EMERGO EUROPE
 Prinsessegracht 20
 2514 AP The Hague
 The Netherlands

EMERGO AUSTRALIA
 201 Sussex Street
 Darling Park, Tower II, Level 20
 Sydney NSW 2000
 Australia

G A M E  R E A D Y®



COOLSYSTEMS®, INC.
DBA GAME READY®
1800 SUTTER STREET, SUITE 500
CONCORD, CA 94520 USA

1.888.GAMEREADEY +1.510.868.2100

www.gameready.com

www.gameready.com/patents

© 2019 CoolSystems, Inc. All rights reserved.
Med4 Elite Control Unit User Manual PN 704444 Rev J